



PICSimLab 0.9.0

Luis Claudio Gambôa Lopes <lcgamboa@yahoo.com>

Download: [github](#)

[HTML version of documentation](#)

[PICSimLab on Twitter](#)

[PICSimLab on Discord](#)

October 22, 2023

Contents

1	Introduction	6
2	Install	8
2.1	Stable version executables download	8
2.2	Unstable version executables download	8
2.3	Install from source	8
2.3.1	Linux	8
2.3.2	Windows	9
2.3.3	macOS	9
2.3.4	Experimental version	9
3	Simulator Interface	10
3.1	Main Window	10
3.2	Interaction with the Board	12
3.3	Command Line	13
3.4	Remote Control Interface	13
3.5	Picture Map Reference	16
4	Boards	18
4.1	Arduino Mega	20
4.2	Arduino Nano	20
4.3	Arduino Uno	21
4.4	Blue Pill	21
4.5	Breadboard	22
4.6	Curiosity	22
4.7	Curiosity HPC	23
4.8	ESP32-C3-DevKitC-02	23
4.9	ESP32-DevKitC	24
4.10	Franzinhos DIY	24
4.11	K16F	25
4.12	McLab1	26
4.13	McLab2	26
4.14	PICGenios	27
4.15	PQDB	29

4.16	Remote TCP	29
4.17	STM32 H103	30
4.18	X	30
4.19	Xpress	31
4.20	gpboard	32
4.21	uCboard	32
5	Serial Communication	33
5.1	Com0com Installation and Configuration(Windows)	33
5.2	tty0tty Installation and Configuration (Linux)	35
5.3	Arduino IDE Integration (simavr)	36
6	Backend Simulators	37
6.1	PICsim	37
6.1.1	MPLABX Integrated Debug	37
6.2	simavr	37
6.2.1	avr-gdb Debug	38
6.2.2	MPLABX Int. Debug	38
6.3	qemu-stm32	38
6.3.1	arm-gdb Debug	39
6.4	qemu-ESP32	39
6.4.1	ESP32-gdb Debug	40
6.5	uCsim	40
6.5.1	uCsim Debug	40
6.6	gpsim	41
6.7	Remote	41
7	Tools	42
7.1	Serial Terminal	42
7.2	Serial Remote Tank	43
7.2.1	Actuators	43
7.2.2	Sensors	44
7.2.3	Communication Protocol	44
7.3	Esp8266 Modem Simulator	45
7.3.1	Supported Commands	46
7.4	Arduino Bootloader	47
7.5	MPLABX Debugger Plugin	47
7.6	Pin Viewer	47
8	Oscilloscope	48
9	Spare Parts	49
9.1	Pin Alias	53
9.2	Inputs	54
9.2.1	ADXL345 (Accel)	54
9.2.2	BMP180 (Pressure I2C)	55

9.2.3	BMP280 (Pressure I2C)	56
9.2.4	DHT11 (Temp. Hum.)	56
9.2.5	DHT22 (Temp. Hum.)	57
9.2.6	DS1621 (Temperature I2C)	58
9.2.7	DS18B20 (Temperature)	58
9.2.8	Encoder	59
9.2.9	FM50 (Temperature)	59
9.2.10	Fixed Voltage	59
9.2.11	Gamepad	60
9.2.12	Gamepad (Analogic)	61
9.2.13	HX711 (Load Cell Amp)	62
9.2.14	Keypad	62
9.2.15	LDR	64
9.2.16	LM35 (Temperature)	65
9.2.17	MPU6050	65
9.2.18	Potentiometers	66
9.2.19	Potentiometers (Rotary)	67
9.2.20	Push Buttons	68
9.2.21	Push Buttons (Analogic)	68
9.2.22	SHT3X (Temp. Hum.)	68
9.2.23	Switches	69
9.2.24	Ultrasonic HC-SR04	70
9.3	Outputs	70
9.3.1	7 Segments Display	70
9.3.2	7 Segments Display (Decoder)	72
9.3.3	Buzzer	73
9.3.4	DC Motor	74
9.3.5	LCD hd44780	75
9.3.6	LCD ili9341	77
9.3.7	LCD pcf8833	78
9.3.8	LCD pcd8544	79
9.3.9	LCD ssd1306	79
9.3.10	LED Matrix	80
9.3.11	LEDs	80
9.3.12	RGB LED	81
9.3.13	RGB LED WS2812B	81
9.3.14	Servo Motor	82
9.3.15	Step Motor	83
9.4	Others	84
9.4.1	ETH w5500	84
9.4.2	IO 74xx573	85
9.4.3	IO 74xx595	85
9.4.4	IO MCP23S17	86
9.4.5	IO MM74C922	86
9.4.6	IO PCF8574	87
9.4.7	IO UART	87

CONTENTS	4
9.4.8 Jumper Wires	88
9.4.9 MEM 24CXXX	88
9.4.10 RTC ds1307	89
9.4.11 RTC pfc8563	89
9.4.12 SD Card	90
9.4.13 Temperature System	91
9.5 Virtual	91
9.5.1 D. Transfer Function	91
9.5.2 IO Virtual Term	92
9.5.3 Signal Generator	92
9.5.4 Text Box	93
9.5.5 VCD Dump	93
9.5.6 VCD Dump (Analogic)	94
9.5.7 VCD Play	94
10 Troubleshooting	96
11 License	97
A Online Simulator	98
B Use with MPLABX	100
B.1 Installing the Necessary Tools	100
B.1.1 Install MPLABX IDE and XC8 Compiler	100
B.1.2 Install PICsimLab	101
B.1.3 How to Install PICSimLab MPLABX Debugger plugin	101
B.2 Configuring a New Project in MPLABX	106
B.2.1 Project Creation	106
B.2.2 File Creation	109
B.2.3 PIC Configuration Bits	110
B.2.4 Code Example	111
B.2.5 Building the Project	112
B.3 Program and Debug PICsimLab With MPLABX	113
B.3.1 Starting PICsimLab	113
B.3.2 Programming PICsimLab	113
B.3.3 Pausing the Program	114
B.3.4 Restarting the Program	114
B.3.5 Running Step by Step	115
B.3.6 Stopping Debugger	116
B.3.7 Disconnect Debugger	116
B.4 This Tutorial in Video	117
C Creating New Boards	118
C.1 Creating a New Board	118
C.1.1 Board Hardware and Schematic	118
C.1.2 Board Picture	121

CONTENTS

5

C.1.3	Picture map	123
C.1.4	Board code	127
C.1.5	Integration with PICsimLab	146
C.1.6	Final Result	146

Chapter 1

Introduction

PICSimLab means Programmable IC Simulator Laboratory

PICSimLab is a realtime emulator of **development boards** with integrated MPLABX/avr-gdb debugger. PICSimLab supports microcontrollers of [picsim](#) , [simavr](#), [uCsim](#), [gpsim](#), [qemu-stm32](#) and [qemu-esp32](#) simulators. PICSimLab have integration with MPLABX/Arduino IDE for programming the boards microcontrollers. As the purpose of PICSimLab is to emulate real hardware it does not have any source code editing support. For code editing and debugging the same tools used for a real board should be used with PIC-SimLab, such as MPLABX, Arduino IDE or VSCode with PlatformIO.

PICSimLab supports several devices (spare parts) that can be connected to the boards for simulation. As for example LEDs and push buttons for simple outputs and inputs and some more complex ones like the ethernet shield w5500 for internet connection or the color graphic display ili9340 with touchscreen. The the complete list of parts can be accessed in the chapter [Spare Parts](#).

The image displays the PICSimLab software interface, which is used for simulating microcontroller-based systems. It is divided into several main sections:

- Top Left: Board Configuration**
 - Window title: `PICSimLab - Arduino Uno - atmega328p`
 - Menu: `File Board Microcontroller Modules Tools Help`
 - Control: `Clock (MHz)` set to 16, `Debug` button.
 - Visual: A 3D model of an Arduino Uno board with the PICSimLab logo and `ATMEGA328P` chip.
 - Status: `Running...`, `Debug: Off`, `Serial: /dev/tty2:9600, 0.`
- Bottom Left: Oscilloscope**
 - Window title: `PICSimLab - Oscilloscope`
 - Channels: `Ch 1 (V)` (2.00), `Ch 1 off` (0.00).
 - Scale: `CH1: 2.00V 0.00V N`, `CH2: 2.00V 0.00V N`. `TM: 0.500ms, 0.000ms`, `TRG CH2: 2.50V`.
 - Channels: `Ch 1` (23 PC0/A0), `Ch 2` (11 PD5/-5).
- Right: Spare Parts Panel**
 - Window title: `PICSimLab - Spare parts`
 - Menu: `File Edit Inputs Outputs Others Virtual Help`
 - Visual: A schematic of the spare parts board with four potentiometers labeled `PC0/A0` (4.15), `PC1/A1` (0.12), `PC2/A2` (0.00), and `NC` (5.00). A red circle highlights the `PD5/-5 PD6/~6 PB1/~9` pin header.
 - Scale: `Scale: 1.2`, `Offset: 0 0`.
 - Input: `Input: ld5`, `CR/LF`, `Char delay: 0 ms`, `Send file...`, `Plain`.
 - Log:

```
[10:15:48:534] sensor = 849.25.0 -> output = 211.6.0 \n
[10:15:48:588] sensor = 849.25.0 -> output = 211.6.0 \n
[10:15:48:643] sensor = 849.25.0 -> output = 211.6.0 \n
[10:15:48:770] sensor = 849.25.0 -> output = 211.6.0 \n
[10:15:48:825] sensor = 849.25.0 -> output = 211.6.0 \n
[10:15:48:951] sensor = 849.25.0 -> output
```
 - Device: `/dev/tty3`, Connection: `115200 @ 8-N-1`

Chapter 2

Install

2.1 Stable version executables download

If you are on Linux or Windows you can download the last version at:

<https://github.com/lcgamboa/picsimlab/releases>

If you are on macOS you can run PICSimLab using Wine:

1. Download and install [‘xquartz’](<https://www.xquartz.org>)
2. Download and install [Wine](<https://dl.winehq.org/wine-builds/macosx/download.html>)
3. Download the executable and double-click it to run the installer

2.2 Unstable version executables download

The binaries of last code available on github can be downloaded at: [Sourceforge.net](https://sourceforge.net)

The unstable test version have the unreleased features of [Changelog_auto.md](#)

If you need a specific binary that is not available please contact me.

2.3 Install from source

2.3.1 Linux

In Debian Linux and derivatives Linux native:

Using a user with permission to run the sudo command:

In first time build:

```
git clone --depth=1 https://github.com/lcgamboa/picsimlab.git
cd picsimlab
bcripts/build_all_and_install.sh
```

To recompile use:

```
make -j4
```

2.3.2 Windows

Cross-compiling for Windows (from Linux or [WSL](#) on win10)

In first time build in Debian Linux and derivatives target Windows 64 bits:

```
git clone https://github.com/lcgamboa/picsimlab.git
cd picsimlab
bscripts/build_w64.sh
```

To recompile use:

```
make FILE=Makefile.cross -j4
```

For target Windows 32 bits:

```
git clone https://github.com/lcgamboa/picsimlab.git
cd picsimlab
bscripts/build_w32.sh
```

To recompile use:

```
make FILE=Makefile.cross_32 -j4
```

2.3.3 macOS

Theoretically it is possible to compile PICSimLab natively on macOS. But I do not have access to any computer with macOS to try to compile and until today nobody has communicated that they managed to do it. (help wanted)

2.3.4 Experimental version

Experimental version can be built using the parameter "exp" on scripts:

```
bscripts/build_all_and_install.sh exp
bscripts/build_w64.sh exp
bscripts/build_w32.sh exp
```

And recompiled using the parameter "exp" on Makefiles:

```
make -j4 exp
make FILE=Makefile.cross -j4 exp
make FILE=Makefile.cross_32 -j4 exp
```

Chapter 3

Simulator Interface

3.1 Main Window

The main window consists of a menu, a status bar, a frequency selection combobox, an on/off button to trigger debugging, some board-specific controls and the part of the board interface itself.

In the title of the window is shown the name of the simulator PICSimLab, followed by the board and the microcontroller in use.

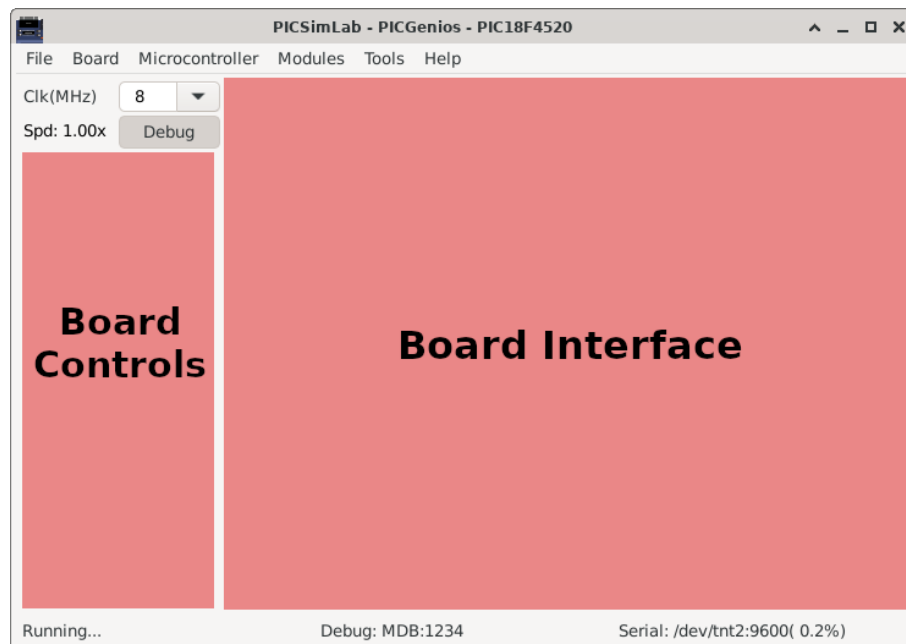

The frequency selection combobox directly changes the working speed of the mi-

crocontroller. The “Spd” label show the ratio between simulation speed and real time. when the “Spd” label goes red indicates that the computer is not being able to run the program in real time for the selected clock. In this case the simulation may present some difference than expected and the CPU load will be increased.

The on/off button to enable debugging is used to enable debugging support, when active simulation load is increased.

The menus and their functions are listed below:

- File
 - Load Hex - Load .hex files
 - Reload Last - Reload the last used .hex file
 - Save Hex - Save memory in a .hex file
 - Configure - Open the configuration windows
 - Save Workspace - Saves all current workspace settings to a .pzw file
 - Load Workspace - Loads saved settings from a .pzw file
 - Exit
- Board
 - Arduino Uno - Choose board Arduino Uno
 - Breadboard - Choose board Breadboard
 - Franzininho - Choose board Franzininho
 - K16F - Choose board K16F
 - McLab1 - Choose board McLab1
 - McLab2 - Choose board McLab2
 - PICGenios - Choose board PICGenios
 - PQDB - Choose board PQDB
 - uCboard - Choose board uCboard
- Microcontroller
 - xxxxx - Selects the microcontroller to be used (depends on the selected board)
- Modules
 - Oscilloscope - Open the oscilloscope window
 - Spare parts - Open the spare parts window
- Tools
 - Serial Terminal - Open the serial terminal (default **Cutecom**)
 - Serial Remote Tank - Open the **remote tank simulator**

- Esp8266 Modem Simulator - Open the [Esp8266 Modem Simulator](#)
- Arduino Bootloader - Load microcontroller with [Arduino serial bootloader](#)
- MPLABX Debugger Plugin - Open the web page to download the [MPLABX Debugger Plugin](#)
- Pin Viewer - Open the [Pin Viewer](#)
- Help
 - Contents - Open the Help window
 - Board - Open the Board Help window
 - Examples - Load the examples
 - About Board - Show message about author and version of board
 - About PICSimLab - Show message about author and version of PICSimLab

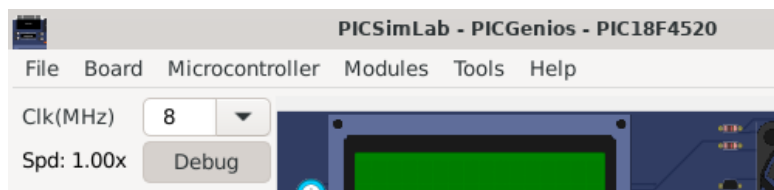

The first part of the status bar shows the state of the simulation, in the middle part the status of the debug support and in the last part the name of the serial port used, its default speed and the error in relation to the real speed configured in the microcontroller.

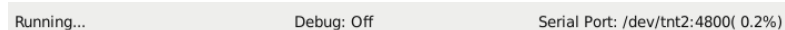

3.2 Interaction with the Board

On the interface area of the board it is possible to interact in some ways:

- Click in ICSP connector to load an .hex file.
- Click in PWR button to ON/OFF the emulator..
- The buttons can be activated through mouse or keys 1, 2, 3 e 4.
- Click and drag in potentiometers to change their values.
- Click on EEPROM memory to view its contents.

3.3 Command Line

PICSimLab supports two command lines format:

One for load a PICSimLab Workspace file (.pzw)

```
picsimlab file.pzw
```

And other for load .hex files

```
picsimlab boardname microcontroller [file.hex] [file.pcf]
```

3.4 Remote Control Interface

The remote control interface allows other programs to control the PICSimLab simulation through a TCP/IP socket using text formatted commands.

The PICSimLab remote control interface supports TCP connections using telnet or nc (netcat).

The default port is 5000 and can be changed in configuration windows.

The 'rlwrap' command can be used for best command edition support in telnet or nc:

```
rlwrap nc 127.0.0.1 5000
```

The supported commands can be shown using the "help" command:

```
help
List of supported commands:
dumpe [a] [s]- dump internal EEPROM memory
dumpf [a] [s]- dump Flash memory
dumpr [a] [s]- dump RAM memory
exit          - shutdown PICSimLab
get ob        - get object value
help         - show this message
info         - show actual setup info and objects
loadhex file - load hex file (use full path)
pins         - show pins directions and values
pinsl        - show pins formatted info
quit         - exit remote control interface
reset        - reset the board
set ob vl    - set object with value
sim [cmd]    - show simulation status or execute cmd start/stop
sync         - wait to synchronize with timer event
version      - show PICSimLab version
Ok
```

The "info" command show all available "objects" and values:

```

info
Board:      Arduino Uno
Processor:  atmega328p
Frequency:  16000000 Hz
Use Spare:  1
  board.out[00] LD_L= 254
part[00]: LEDs
  part[00].out[08] LD_1= 254
  part[00].out[09] LD_2= 30
  part[00].out[10] LD_3= 254
  part[00].out[11] LD_4= 254
  part[00].out[12] LD_5= 254
  part[00].out[13] LD_6= 254
  part[00].out[14] LD_7= 254
part[01]: Buzzer
  part[01].out[02] LD_1= 140
part[02]: Push buttons
  part[02].in[00] PB_1= 1
  part[02].in[01] PB_2= 0
  part[02].in[02] PB_3= 1
  part[02].in[03] PB_4= 1
  part[02].in[04] PB_5= 1
  part[02].in[05] PB_6= 1
  part[02].in[06] PB_7= 1
  part[02].in[07] PB_8= 1
Ok

```

The “pins” command show all pins directions and digital values:

```

pins
pin[01] ( PC6/RST) < 0
pin[02] ( PD0/0) < 1
pin[03] ( PD1/1) < 1
pin[04] ( PD2/2) < 1
pin[05] ( PD3/~3) > 0
pin[06] ( PD4/4) < 1
pin[07] ( +5V) < 1
pin[08] ( GND) < 0
pin[09] ( PB6/X1) < 0
pin[10] ( PB7/X2) < 0
pin[11] ( PD5/~5) < 1
pin[12] ( PD6/~6) < 1
pin[13] ( PD7/7) < 1
pin[14] ( PB0/8) > 0
pin[15] ( PB1/~9) > 0
pin[16] ( PB2/~10) > 0
pin[17] ( PB3/~11) > 0
pin[18] ( PB4/12) < 0
pin[19] ( PB5/13) > 0
pin[20] ( +5V) < 1
pin[21] ( AREF) < 0
pin[22] ( GND) < 0
pin[23] ( PC0/A0) < 0
pin[24] ( PC1/A1) < 0
pin[25] ( PC2/A2) < 0
pin[26] ( PC3/A3) < 0
pin[27] ( PC4/A4) > 0
pin[28] ( PC5/A5) > 0
Ok

```

The “pinsl” command show all pins info in text formatted output:

```

pinsl
28 pins [atmega328p]:
pin[01] D I 0 000 0.000 "PC6/RST "
pin[02] D I 1 200 0.000 "PD0/0 "
pin[03] D I 1 200 0.000 "PD1/1 "
pin[04] D I 1 200 0.000 "PD2/2 "
pin[05] D O 0 007 0.000 "PD3/~3 "
pin[06] D I 1 200 0.000 "PD4/4 "
pin[07] P I 1 200 0.000 "+5V "
pin[08] P I 0 000 0.000 "GND "
pin[09] D I 0 000 0.000 "PB6/X1 "
pin[10] D I 0 000 0.000 "PB7/X2 "
pin[11] D I 1 200 0.000 "PD5/~5 "
pin[12] D I 1 200 0.000 "PD6/~6 "
pin[13] D I 1 200 0.000 "PD7/7 "
pin[14] D O 0 000 0.000 "PB0/8 "
pin[15] D O 0 000 0.000 "PB1/~9 "
pin[16] D O 0 000 0.000 "PB2/~10 "
pin[17] D O 0 006 0.000 "PB3/~11 "
pin[18] D I 0 000 0.000 "PB4/12 "
pin[19] D O 0 000 0.000 "PB5/13 "
pin[20] P I 1 200 0.000 "+5V "
pin[21] R I 0 000 0.000 "AREF "
pin[22] P I 0 000 0.000 "GND "
pin[23] A I 0 000 0.875 "PC0/A0 "
pin[24] A I 0 000 1.925 "PC1/A1 "
pin[25] A I 0 000 2.700 "PC2/A2 "
pin[26] A I 0 000 4.275 "PC3/A3 "
pin[27] D O 1 179 0.000 "PC4/A4 "
pin[28] D O 1 186 0.000 "PC5/A5 "
Ok

```

You can view one input/output state using the “get” command:

```

get board.out[00]

get part[02].in[01]

```

Its possible use the “get” command to view individual pins state:

```

#digital state
get pin[19]
pin[19]= 0
Ok

#digital mean value (0-200)
get pinm[19]
pin[18]= 100

```

```
Ok

#analog state
get apin[25]
apin[25]= 2.700
Ok

#all info
get pinl[13]
pin[13] D I 1 200 0.000 "PD7/7  "
Ok
```

And set value of one input using the “set” command:

```
set part[02].in[01] 0
set part[02].in[01] 1
```

Or set value of one pin using the “set” command:

```
#digital
set pin[10] 2

#analog
set apin[20] 2.345
```

For windows users [putty telnet client](#) is a good option to access the remote control interface.

3.5 Picture Map Reference

Names used in .map files for boards and parts are standardized and used by the remote control interface.

The names must start with **I_** if it is an input, **O_** if it is an output or **B_** if it is bidirectional. And be followed by one of the two-letter types in the table below before the area name.

Function	Type	Description	RControl In	RControl Out
I	MD	Memory Dump	-	-
I	KB	Keyboard Key	0 or 1	0 or 1
I	PG	Program	-	-
I	CN	Connector	-	-
B	PO	Potentiometer	0 to 200	0 to 200
B	JP	Jumper	0 or 1	0 or 1
B	VS	Value short	-32768 to 32767	-32768 to 32767
B	PB	Push button	0 or 1	0 or 1
B	DP	Dip switch	0 or 1	0 or 1
B	SW	Switch	0 or 1	0 or 1
B	RT	Rotary encoder	0 to 200	0 to 200
B	AJ	Dip switch	-	-
O	MC	Motor Cooler	-	0 to 200
O	PN	Pin name	-	-
O	ST	Status	-	-
O	IC	IC name	-	-
O	LR	LED RGB	-	-
O	LM	LED Matrix	-	-
O	DI	Display Info	-	-
O	LD	LED	-	0 to 200
O	DS	Display	-	if alphanumeric show text
O	MT	DC motor	-	dir 0 or 1, spd. 0 to 200, pos. 0 to 200
O	DG	Degree	-	float angle
O	SS	seven segment	-	decoded number

For example area named **B_PB_Start**, which describes the position of a push button named "Start". The **B_** bidirectional indicates that the mapped area serves as user action input and drawing output.

Chapter 4

Boards

PICSimLab currently supports five backend simulators: `picsim`, `simavr`, `uCsim`, `gpsim` and `qemu` (`stm32` and `esp32`).

The Figure below shows which boards are based on which backend simulator:

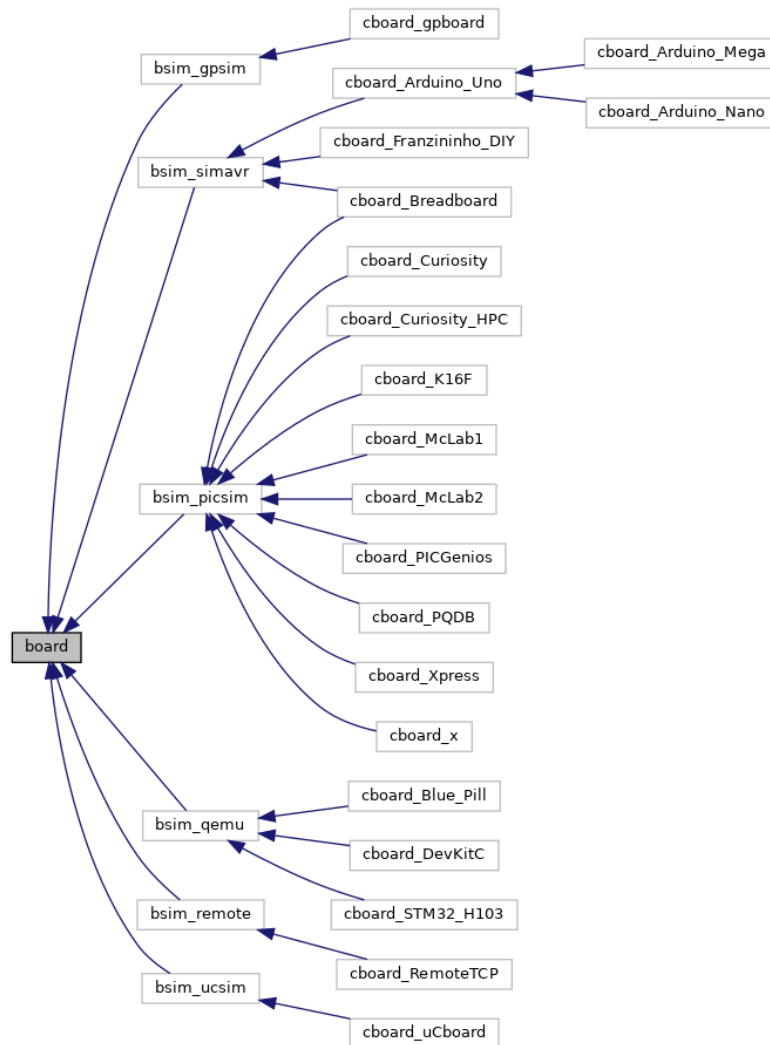

Figure 4.1: Boards backend simulators

The below table show the supported debug interface of each simulator:

Backend	Debug Support
picsim	see the section MPLABX Integrated Debug
simavr	see the sections MPLABX Integrated Debug and remote avr-gdb Debug
qemu-stm32	see the section remote arm-gdb Debug
qemu-esp32	see the section remote esp32-gdb Debug
uCsim	see the section uCsim remote console (telnet) Debug
gpsim	none yet

4.1 Arduino Mega

It emulates the Arduino Mega development board that uses one ATMEGA2560 microcontroller of [simavr backend simulator](#).

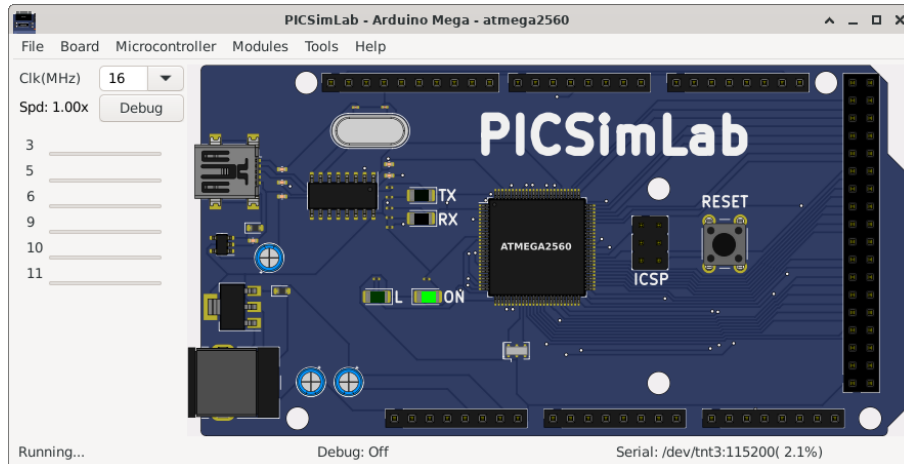

The code examples can be loaded in PICSimLab menu **Help->Examples**.

The source code of board Arduino Mega examples using the [Arduino IDE with avr-gcc](#) are in the link: [board_Arduino_Mega](#).

More information about the Arduino in [www.arduino.cc](#)

Information on how to configure the PICSimLab integration with the Arduino IDE can be found in the section: [Arduino IDE Integration](#).

4.2 Arduino Nano

It emulates the Arduino Nano development board that uses one ATMEGA328P microcontroller of [simavr backend simulator](#).

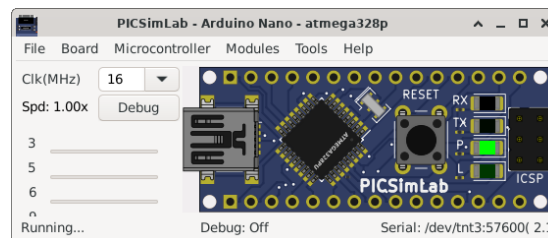

The code examples can be loaded in PICSimLab menu **Help->Examples**.

The source code of board Arduino Nano examples using the [Arduino IDE with avr-gcc](#) are in the link: [board_Arduino_Nano](#).

More information about the Arduino in [www.arduino.cc](#)

Information on how to configure the PICSimLab integration with the Arduino IDE can be found in the section: [Arduino IDE Integration](#).

4.3 Arduino Uno

It emulates the Arduino Uno development board that uses one ATMEGA328P microcontroller of [simavr backend simulator](#).

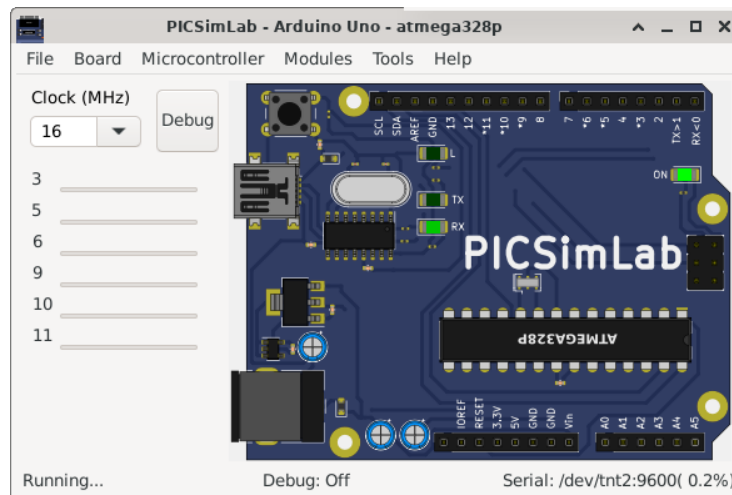

[Board Arduino Uno schematics](#).

The code examples can be loaded in PICSimLab menu **Help->Examples**.

The source code of board Arduino Uno examples using the [Arduino IDE with avr-gcc](#) are in the link: [board_Arduino_Uno](#).

More information about the Arduino in www.arduino.cc

Information on how to configure the PICSimLab integration with the Arduino IDE can be found in the section: [Arduino IDE Integration](#).

4.4 Blue Pill

It is a generic board only with reset, serial and crystal circuits and support to stm32f103c8t6 microcontroller of [qemu-stm32 backend simulator](#).

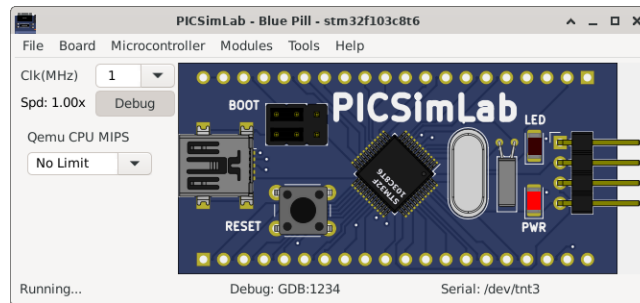

[Board Blue Pill schematics.](#)

[Examples](#)

4.5 Breadboard

It is a generic board only with reset, serial and crystal circuits and support to multiple microcontrollers of **PICSim** and **simavr** backend simulators.

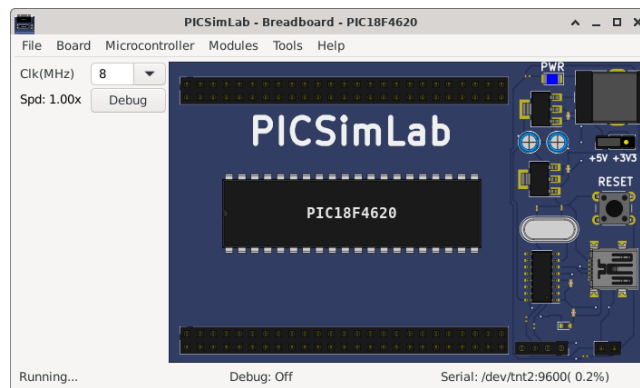

[Board Breadboard schematics.](#)

[Examples](#)

4.6 Curiosity

This is a simple PIC microcontroller development board that uses the **PICSim backend simulator**.

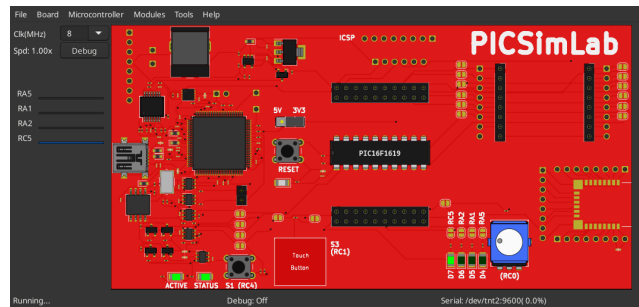

Examples

4.7 Curiosity HPC

This is a simple PIC microcontroller development board that uses the **PICSim backend simulator**.

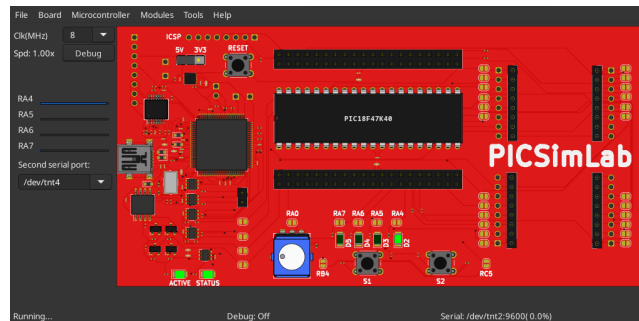

Examples

4.8 ESP32-C3-DevKitC-02

It is a simple board only with reset, serial and crystal circuits and support for ESP32-C3 microcontroller of **qemu-esp32 backend simulator**.

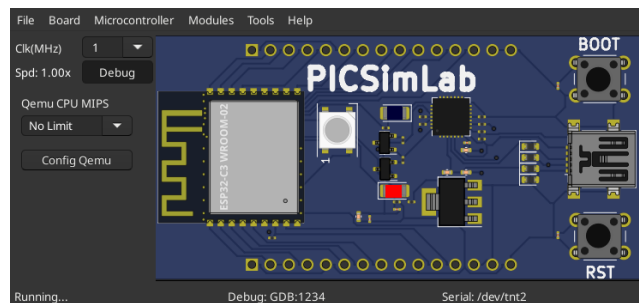

[Board DevKitC-02 schematics.](#)

[Examples](#)

4.9 ESP32-DevKitC

It is a simple board only with reset, serial and crystal circuits and support for ESP32 microcontroller of [qemu-esp32 backend simulator](#).

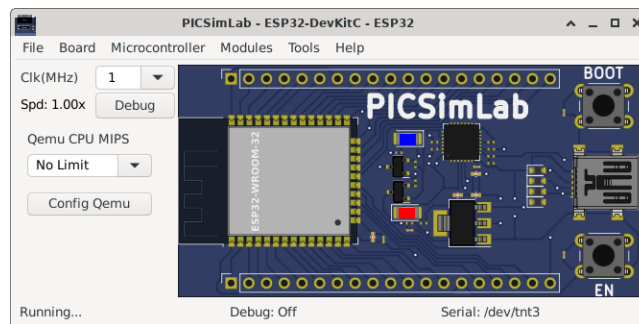

[Board DevKitC schematics.](#)

[Examples](#)

4.10 Franzininho DIY

The Franzininho DIY board is an openhardware project, more info at <https://franzininho.com.br/>. It was developed to be used with the microcontroller ATtiny85 of [simavr backend simulator](#).

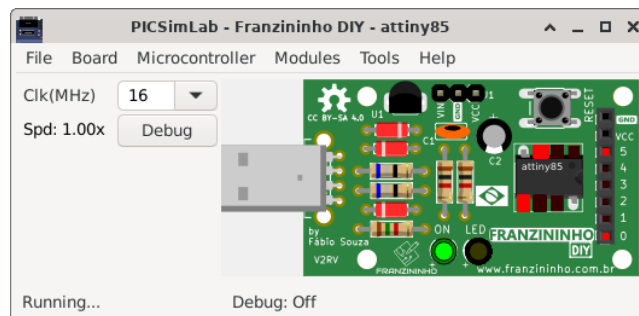

[Board Franzininho DIY schematics.](#)

[Examples](#)

4.11 K16F

It emulates an didactic board developed by author that uses one PIC16F84, PIC16F628 or PIC16F648 of **PICSim backend simulator**.

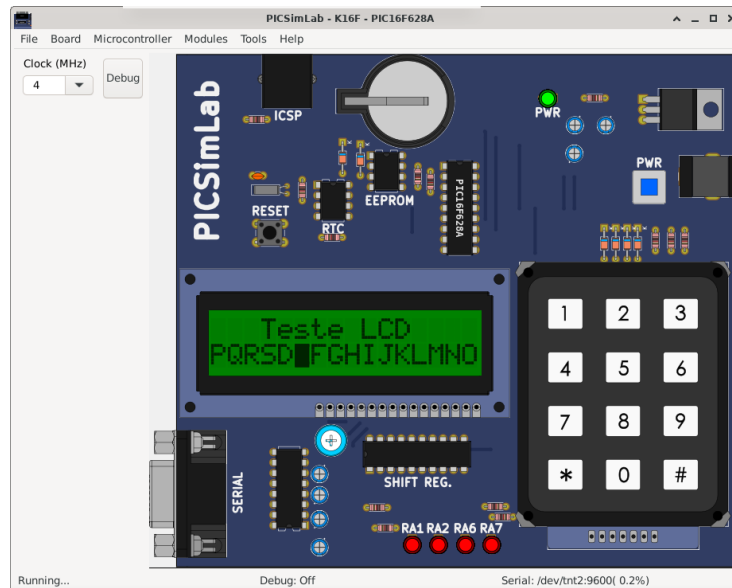
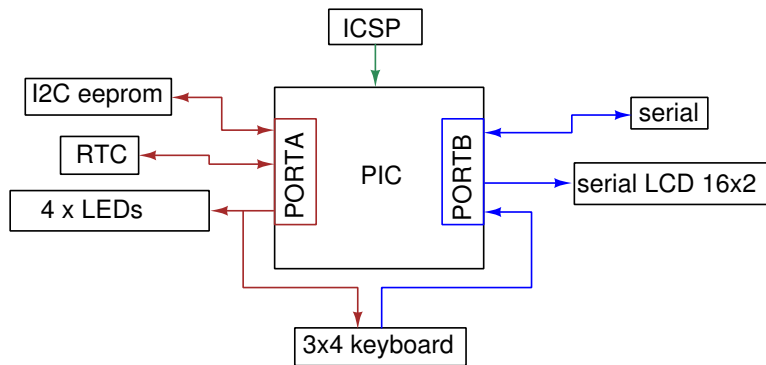

[Board K16F schematics.](#)

The code examples can be loaded in PICSimLab menu **Help->Examples**.

The source code of board K16F examples using **MPLABX** and **XC8** compiler are in the link: [board_K16F](#).

4.12 McLab1

It emulates the Labtools development board McLab1 that uses one PIC16F84, PIC16F628 or PIC16F648 of **PICSim backend simulator**.

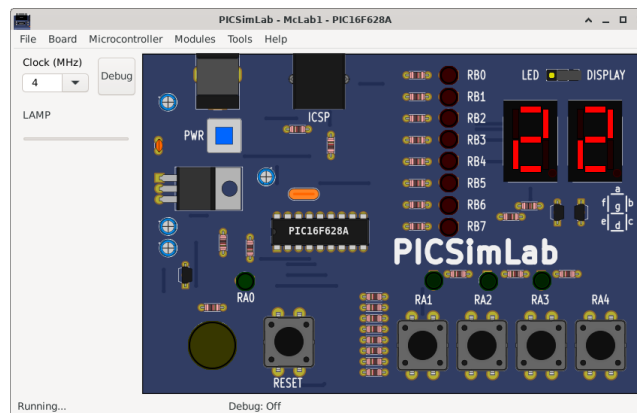
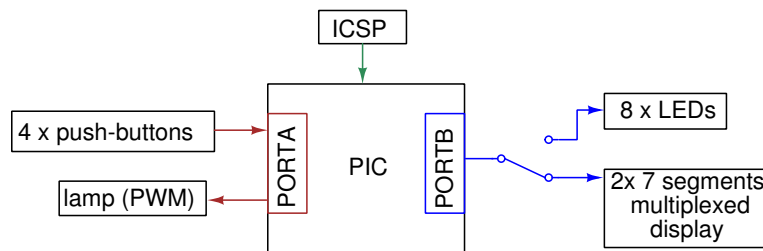

[Board McLab1 schematics.](#)

The code examples can be loaded in PICSimLab menu **Help->Examples**.

The source code of board McLab1 examples using [MPLABX](#) and [XC8](#) compiler are in the link: [board_McLab1](#).

4.13 McLab2

It emulates the Labtools development board McLab2 that uses one PIC16F777, PIC16F877A, PIC18F452, PIC18F4520, PIC18F4550 or PIC18F4620 of **PICSim backend simulator**..

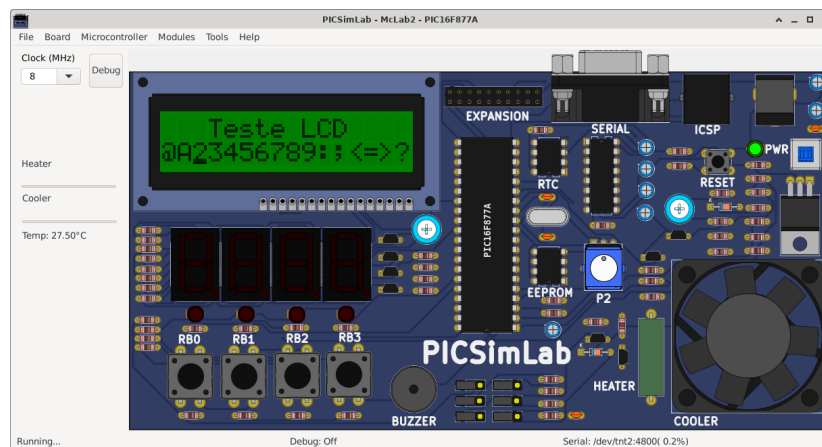
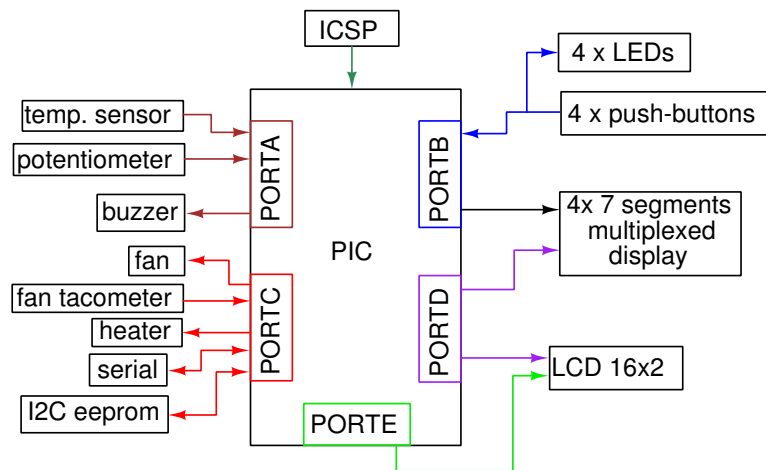

[Board McLab2 schematics.](#)

The code examples can be loaded in PICSimLab menu **Help->Examples**.

The source code of board McLab2 examples using [MPLABX](#) and [XC8](#) compiler are in the link: [board_McLab2](#).

4.14 PICGenios

It emulates the microgenius development board PICGenios PIC18F e PIC16F Microchip that uses one PIC16F777, PIC16F877A, PIC18F452, PIC18F4520, PIC18F4550 or PIC18F4620 of [PICSim backend simulator](#).

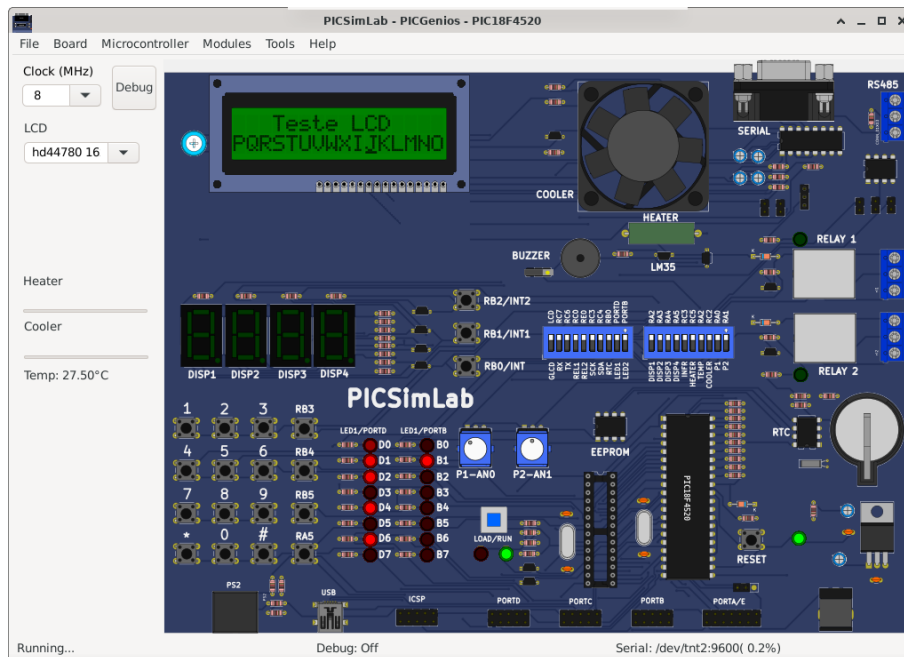
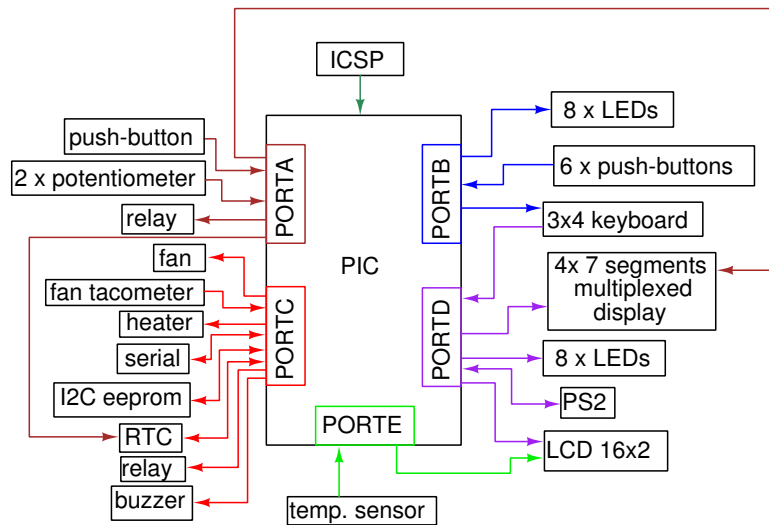

Board PICGenios schematics.

The code examples can be loaded in PICSimLab menu **Help->Examples**.

The source code of board PICGenios examples using [MPLABX](#) and [XC8](#) compiler are in the link: [board_PICGenios](#).

4.15 PQDB

The PQDB board is an opensource/openhardware project, more info at <https://github.com/projetopqdb/>. It was developed to be used with arduino/freedom boards, but adapted to use the microcontroller PIC18F4520 of [PICSim backend simulator](#) on PICSimLab.

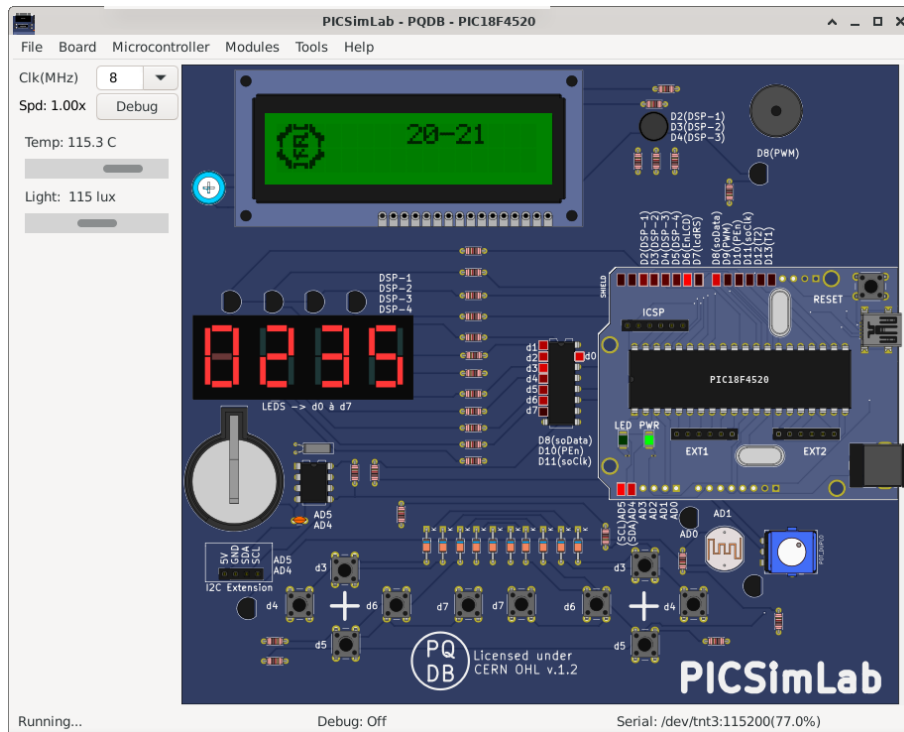

[Board PQDB schematics.](#)

[Hat board PIC18F schematics.](#)

[Examples](#)

4.16 Remote TCP

It is a virtual board controlled through one TCP connection. Currently only supports the Risc-V simulator [Ripes](#) and uses the [remote backend simulator](#).

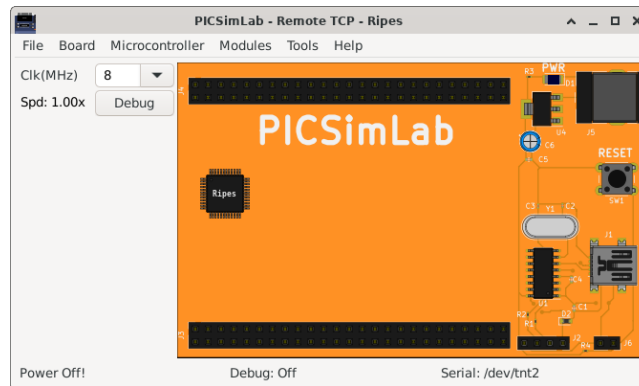

Examples

4.17 STM32 H103

It is a generic board only with reset, one push button, serial and crystal circuits and support to stm32f103rbt6 microcontroller of [qemu-stm32 backend simulator](#).

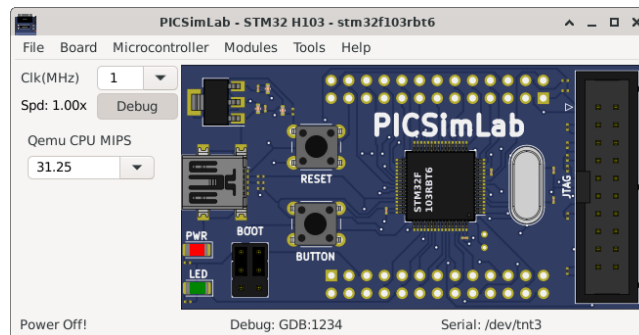

[Board STM32 H103 schematics.](#)

Examples

4.18 X

It is a generic board, used as example in the tutorial [Creating New Boards](#). This board uses one PIC16F877A, PIC18F4550 or PIC18F4620 of [PICSim backend simulator](#).

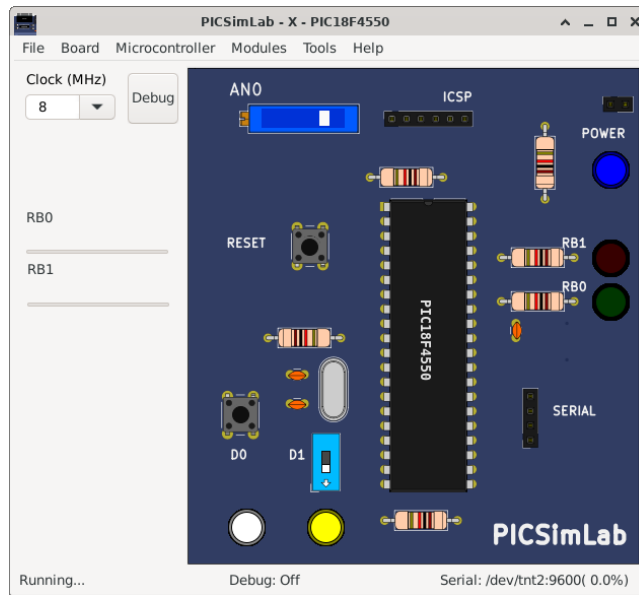

Board X schematics.

Examples

4.19 Xpress

This is a simple PIC microcontroller development board that uses the [PICSim backend simulator](#).

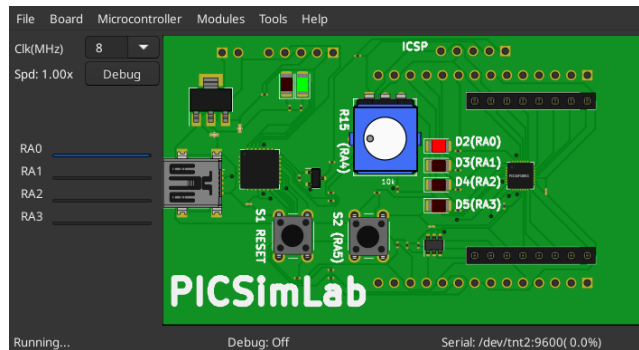

Examples

4.20 gpboard

It is a generic board only with reset, serial and crystal circuits and support to multiple microcontrollers of *gpsim backend simulator*..

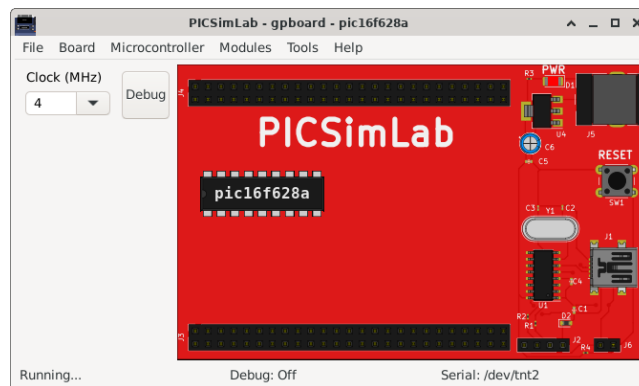

Examples

4.21 uCboard

It is a generic board only with reset, serial and crystal circuits and support to multiple microcontrollers (initially C51, Z80 and STM8S103) of *ucsim backend simulator*..

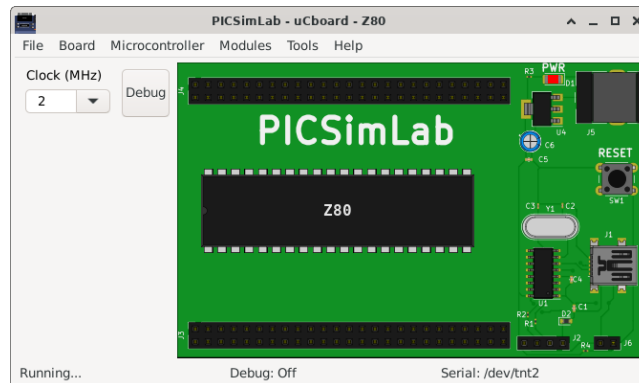

Examples

Chapter 5

Serial Communication

To use the simulator serial port emulation, you must install a NULL-MODEM emulator:

- Windows: com0com <http://sourceforge.net/projects/com0com/>
- Linux: tty0tty <https://github.com/lcgamboa/tty0tty>

For communication the PICSimLab should be connected in one port of the NULL-MODEM emulator and the other application connected in the other port. Configuration examples linking PICSimLab to [Cutecom](#) for serial communication:

OS	PicsimLab port	Cutecom port	NULL-Modem prog.	Connection
Windows	com1	com2	com0com	com1<=>com2
Linux	/dev/tnt2	/dev/tnt3	tty0tty	/dev/tnt2<=>/dev/tnt3

The PICSimLab serial communication uses the 8N1 format.

5.1 Com0com Installation and Configuration(Windows)

Download the signed version of [com0com](#).

Unzip the downloaded .zip file and run the specific installer of your operating system, x86 for windows 32-bit or x64 for windows 64-bit.

Configure the “choose components” window as the figure below:

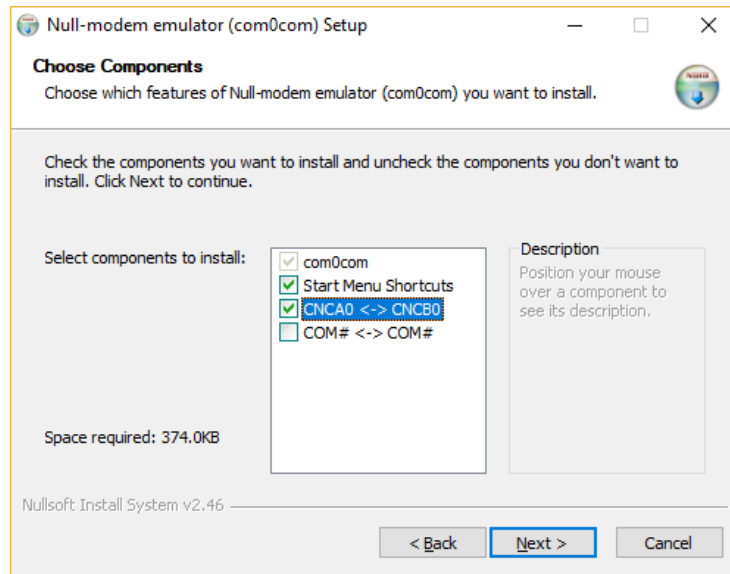

In the last configuration window, check the “Launch setup” option:

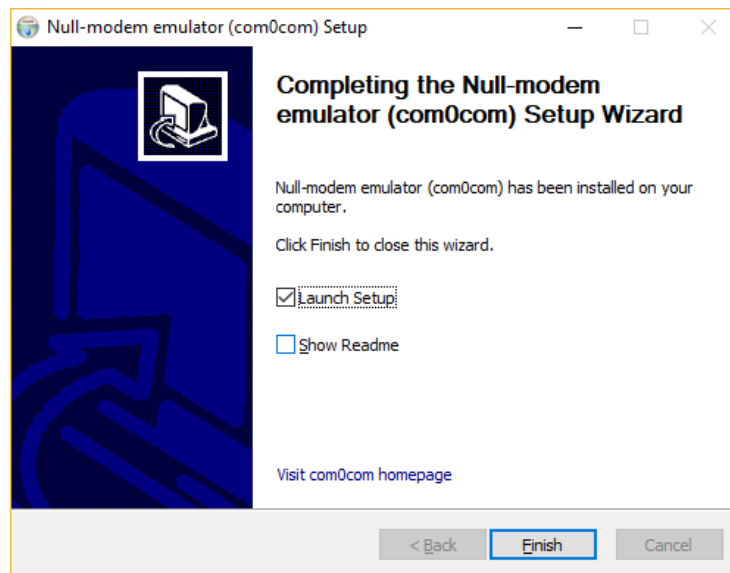

In the setup window, change the port names to COM1, COM2, COM3 Just check the “enable buffer overrun” and “use Port class” options on the port used to CuteCom, click in the “Apply” button and close the setup. In the configuration shown in the figure below, the port COM1 (with buffer overrun disabled) must be used by the PICSimLab and COM2 (with buffer overrun enabled) by the application with serial communication.

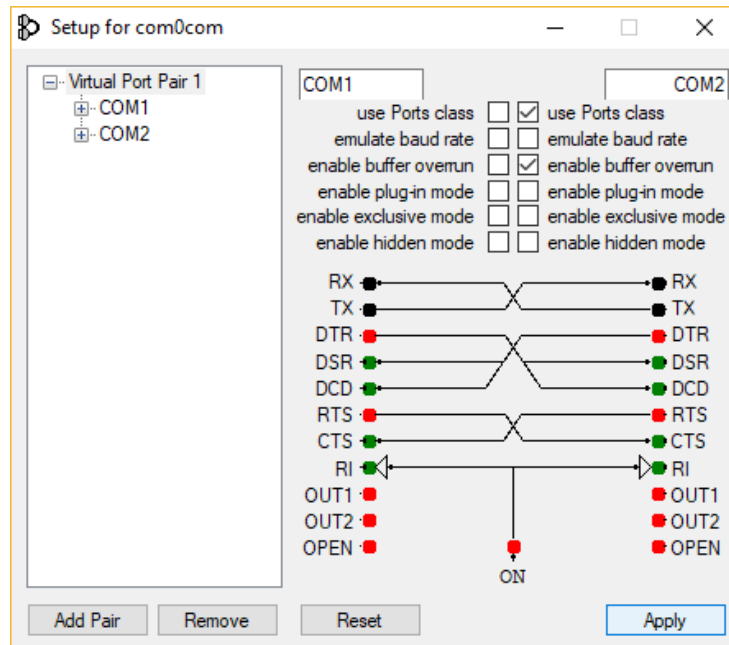

5.2 tty0tty Installation and Configuration (Linux)

Download the [tty0tty](#). Unzip the downloaded folder.

Open a terminal and enter in the `tty0tty/module/` folder and enter the following commands:

```
sudo apt-get update
sudo apt-get -y upgrade
sudo apt-get -y install gcc make linux-headers-`uname -r`
sudo ./dkms-install.sh
sudo modprobe tty0tty
```

The user must be in the **dialout** group to access the ports. To add your user to **dialout** group use the command:

```
sudo usermod -a -G dialout your_user_name
```

after this is necessary logout and login to group permissions take effect.

Once installed, the module creates 8 interconnected ports as follows:

```
/dev/tnt0 <=> /dev/tnt1
/dev/tnt2 <=> /dev/tnt3
/dev/tnt4 <=> /dev/tnt5
/dev/tnt6 <=> /dev/tnt7
```

the connection between each pair is of the form:

```
TX    ->  RX
RX    <-  TX
RTS   ->  CTS
CTS   <-  RTS
DSR   <-  DTR
CD    <-  DTR
DTR   ->  DSR
DTR   ->  CD
```

Any pair of ports form a NULL-MODEM connection, where one port must be used by the PICSimLab and another by the application with serial communication.

5.3 Arduino IDE Integration (simavr)

For integrated use with the Arduino IDE, simply configure the serial port as explained in the Chapter [Serial Communication](#) and load the Arduino bootloader. The bootloader can be loaded from the “Tools->Arduino bootloader” menu.

In Windows, considering com0com making a NULL-MODEM connection between COM1 and COM2, simply connect the PICSimLab on the COM1 port (defined in configuration window) and the Arduino IDE on the COM2 port or vice versa.

On Linux the operation is the same, but using for example the ports /dev/tnt2 and /dev/tnt3.

In Linux for the virtual ports to be detected in Arduino IDE 1.8.xx it is necessary to replace the library lib/liblistSerialsj.so of the Arduino with a version which support the detection of ttyOtty ports, that can be downloaded in the link [listSerialC with ttyOtty support](#). The Arduino IDE 2.0 does not yet support virtual port detection, consider using IDE version 1.8 or vscode.

Chapter 6

Backend Simulators

PICSimLab currently supports five backend simulators: [picsim](#), [simavr](#), [uCsim](#), [gpsim](#) and [qemu](#) ([stm32](#) and [esp32](#)).

The type of debug interface depends on the backend simulator utilized.

6.1 PICsim

“[PICsim](#) emulates some PIC microcontroller and peripherals such as USART and timers, the simulator architecture permit easy implementation of external elements in c language. It can be used as a standalone simulator ([picsim](#) executable) or as a library in other programs (As in [PICSimLab](#)).”

6.1.1 MPLABX Integrated Debug

To use the [MPLABX](#) IDE for debug and program the [PicsimLab](#), install the plugin [com-picsim-picsimlab.nbm](#) in [MPLABX](#).

The plugin connect to [PICSimLab](#) through a TCP socket using port 1234 (or other defined in configuration window), and you have to allow the access in the firewall.

[Tutorial: how to use MPLABX to program and debug PICsimLab.](#)

6.2 simavr

“[simavr](#) is a new AVR simulator for linux, or any platform that uses [avr-gcc](#). It uses [avr-gcc](#)’s own register definition to simplify creating new targets for supported AVR devices. The core was made to be small and compact, and hackable so allow quick prototyping of an AVR project. The AVR core is now stable for use with parts with <= 128KB flash, and with preliminary support for the bigger parts. The simulator loads ELF files directly, and there is even a way to specify simulation parameters directly in the emulated code using an [.elf](#) section. You can also load multipart HEX files.”

6.2.1 avr-gdb Debug

With debug support enabled you can use `avr-gdb` to debug the code used in the simulator. Use the configuration window to choose between MDB (MPLABX) or GDB to debug AVR microcontrollers.

Use `avr-gdb` with the `.elf` file as the parameter:

```
avr-gdb compiled_file.elf
```

and the command below to connect (1234 is the default port):

```
target remote localhost:1234
```

Graphic debug mode can be made using [eclipse IDE](#) with [Sloeber Arduino plugin](#).

It is also possible to debug using [platformIO in VSCode](#), just add the configuration lines below in the project's `platformio.ini` file:

```
build_type = debug
upload_port = COM7
;upload_port = /dev/tnt3
debug_tool = custom
debug_port = localhost:1234
debug_build_flags = -O2 -g
debug_init_break = tbreak setup
debug_init_cmds =
    define pio_reset_halt_target
    end
    define pio_reset_run_target
    end
    target extended-remote $DEBUG_PORT
    $LOAD_CMDS
    pio_reset_halt_target
    $INIT_BREAK
```

6.2.2 MPLABX Int. Debug

PICSimLab also supports using MPLABX to debug `simavr`. The configuration is the same as described in PICSim section: [MPLABX Integrated Debug](#). It's possible import and debug a Arduino sketch into MPLABX using the [Arduino import plugin](#).

6.3 qemu-stm32

“[Qemu STM32](#): QEMU with an STM32 microcontroller implementation”

6.3.1 arm-gdb Debug

With debug support enabled you can use arm-none-eabi-gdb (or gdb-multiarch) to debug the code used in the simulator.

Use arm-none-eabi-gdb with the .elf file as the parameter:

```
arm-none-eabi-gdb compiled_file.elf
```

and the command below to connect (1234 is the default port):

```
target remote localhost:1234
```

Graphic debug mode can be made using [eclipse IDE](#) with [Eclipse Embedded CDT](#) or using [platformIO in VSCode](#), just add the configuration lines below in the project's **platformio.ini** file:

```
upload_port = com7
;upload_port = /dev/tnt2
build_type = debug
debug_tool = custom
debug_port = localhost:1234
debug_build_flags = -O2 -g
debug_init_break = tbreak main
debug_init_cmds =
    define pio_reset_halt_target
        monitor system_reset
    end
    define pio_reset_run_target
        monitor system_reset
    end
target extended-remote $DEBUG_PORT
$LOAD_CMDS
pio_reset_halt_target
$INIT_BREAK
```

6.4 qemu-ESP32

“[Qemu ESP32](#): Qemu Emulator for TTGO TDisplay esp32 board.”

For integrated use with the Arduino IDE or IDF esptool.py , simply configure the serial port as explained in the Chapter [Serial Communication](#) to flash PICSimLab ESP32-DevKitC as a real ESP32 board.

Attention! Qemu ESP32 don't support the QIO and QOUT flash modes, use only DIO or DOUT flash modes.

6.4.1 ESP32-gdb Debug

With debug support enabled you can use `xtensa-esp32-elf-gdb` to debug the code used in the simulator.

Use `xtensa-esp32-elf-gdb` with the `.elf` file as the parameter:

```
xtensa-esp32-elf-gdb compiled_file.elf
```

and the command below to connect (1234 is the default port):

```
target remote localhost:1234
```

Graphic debug mode can be made using [platformIO in VSCode](#), just add the configuration lines below in the project's `platformio.ini` file:

```
upload_port = com7
;upload_port = /dev/tnt2
build_type = debug
debug_tool = custom
debug_port = localhost:1234
debug_build_flags = -O2 -g
debug_init_break = tbreak main
debug_init_cmds =
    define pio_reset_halt_target
        monitor system_reset
    end
    define pio_reset_run_target
        monitor system_reset
    end
target extended-remote $DEBUG_PORT
$LOAD_CMDS
pio_reset_halt_target
$INIT_BREAK
```

6.5 uCsim

“**uCsim** Software simulator for microcontrollers. uCsim can be used to simulate microcontrollers. It supports MCS51 family, AVR core, Z80, HC08, ST7, STM8, TLCS90, XA51 and Padauk. It can run on Linux, Windows, OSX, BSD, and other systems.”

6.5.1 uCsim Debug

The uCsim debug console can be accessed with the telnet (1234 is the default port):

```
telnet localhost 1234
```

All [uCsim commands](#) are supported.

For windows users [putty telnet client](#) is a good option to access the uCsim console.

6.6 gpsim

“[gpsim](#) is a full-featured software simulator for Microchip PIC microcontrollers distributed under the GNU General Public License, Version 2 or higher, and some of its libraries under GNU Lesser General Public License, Version 2 or higher.

gpsim has been designed to be as accurate as possible. Accuracy includes the entire PIC - from the core to the I/O pins and including ALL of the internal peripherals. Thus it's possible to create stimuli and tie them to the I/O pins and test the PIC the same way you would in the real world.”

6.7 Remote

This is experimental support to allow other simulators acting as microcontrollers to control PICSimLab remotely (TCP/IP).

Chapter 7

Tools

7.1 Serial Terminal

Open the serial terminal (with system application associated with .stern file extension), the default application is the [CuteCom](#).

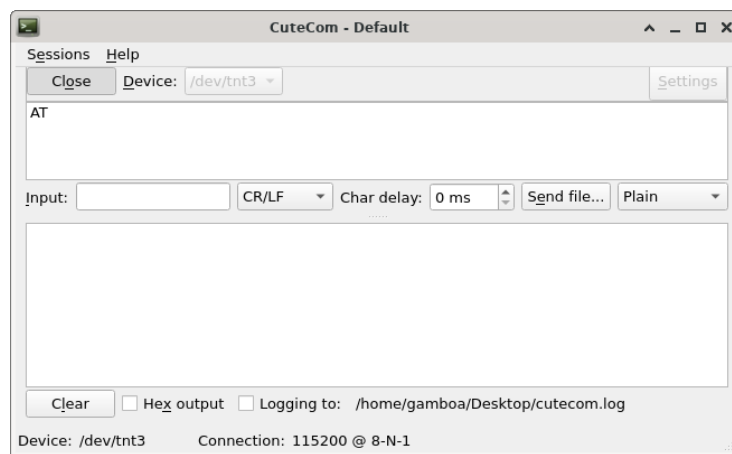

A serial terminal is used to send and receive data over a serial communication channel. The use of this terminal can be replaced by others like the Arduino IDE serial monitor.

To use this tool with PICSimLab you first need to configure a virtual serial port as described in Chapter: [Serial Communication](#). It is possible to use this tool with a real serial port connected to a real device.

7.2 Serial Remote Tank

The serial remote tank is a tank simulator controlled by a serial communication protocol. The tank has several sensors and actuators that can be read and controlled using the communication protocol. The parameters of the serial communication port must be 19200 8N1.

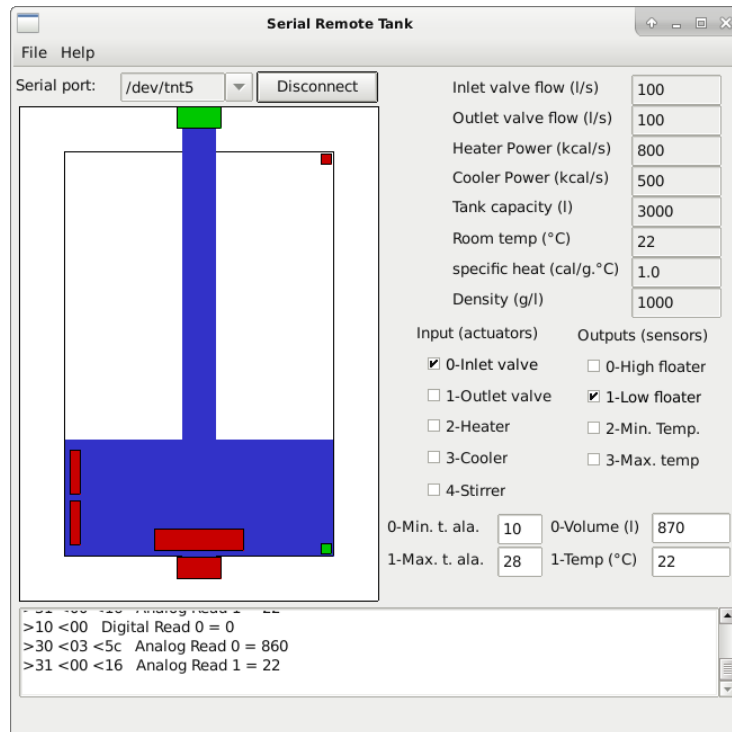

To use this tool with PICSimLab you first need to configure a virtual serial port as described in Chapter: [Serial Communication](#). It is possible to use this tool with a real serial port connected to a real device.

7.2.1 Actuators

Digital inputs:

1. Inlet valve
2. Outlet valve
3. Heater
4. Cooler
5. Stirrer

Analog inputs:

1. Minimal temperature alarm trigger level
2. Maximal temperature alarm trigger level

7.2.2 Sensors

Digital outputs:

1. High floater
2. Low floater
3. Minimal temperature
4. Maximal temperature

Analog outputs:

1. Volume
2. Temperature

7.2.3 Communication Protocol

Writing on Digital Input

Sent one byte in 0x0N hexadecimal format where N is the number of input followed by a second byte with value 0x00 for disable or 0x01 for enable.

Example to turn on the input 2:

```
Serial_write(0x02);  
Serial_write(0x01);
```

Reading Digital Output

Sent one byte in 0x1N hexadecimal format where N is the number of output and read one byte. The byte readed have value 0x00 for disable or 0x01 for enable.

Example to read output 3:

```
Serial_write(0x13);  
valor=Serial_read(0);
```

Writing on Analog Input

Sent one byte in 0x2N hexadecimal format where N is the number of input followed by two bytes with the 16 bits value.

Example to write the value 230 on analog input 1:

```
Serial_write(0x21);  
valor=230;  
Serial_write((valor&0xFF00)>>8);  
Serial_write(valor&0x00FF);
```

Reading Analog Output

Sent one byte in 0x3N hexadecimal format where N is the number of output and read two bytes to form the 16 bits value.

Example to read analog output 2:

```
Serial_write(0x32);  
valorh=Serial_read(0);  
valorl=Serial_read(0);  
valor=(valorh<<8)|valorl;
```

7.3 Esp8266 Modem Simulator

The ESP8266 modem simulator emulates the operation of an esp8266 with wifi modem firmware. Communication is done using a serial channel via AT modem commands. The parameters of the serial communication port must be 115200 8N1.

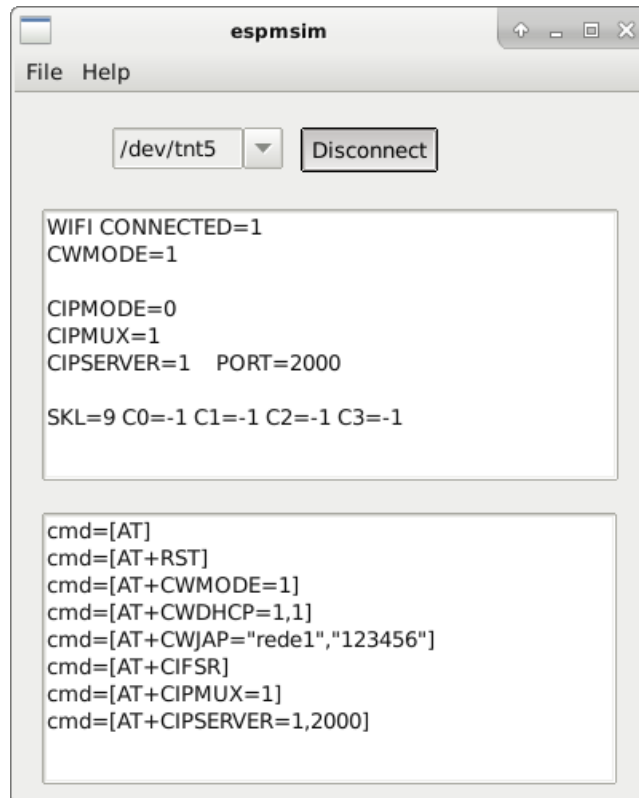

To use this tool with PICSimLab you first need to configure a virtual serial port as described in Chapter: [Serial Communication](#). It is possible to use this tool with a real serial port connected to a real device.

7.3.1 Supported Commands

- AT
- AT+RST
- AT+GMR
- AT+CWMODE=1
- AT+CWDHCP=1,1
- AT+CWLAP
- AT+CWJAP="rede1", "123456"
- AT+CIFSR
- AT+CIPMUX=1

- AT+CIPSERVER=1,2000
- AT+CIPSEND=0,10
- AT+CIPCLOSE=0

7.4 Arduino Bootloader

This menu option load PICSimLab microcontroller with Arduino serial bootloader. The microcontroller with the bootloader loaded can be programmed directly by the Arduino IDE or using the avrdude program.

To use this tool with PICSimLab you first need to configure a virtual serial port as described in Chapter: [Serial Communication](#).

7.5 MPLABX Debugger Plugin

This menu option open the web page to download the MPLABX Debugger Plugin.

The plugin must be installed on MPLABX to allow debugging and programming PICSimLab (PICs and AVR) from the IDE, like a real tool for debugging and programming.

7.6 Pin Viewer

The PinViewer connects to PICSimLab through the [rcontrol interface](#) and allows viewing the status and direction of all microcontroller pins. It is also possible to change the state of the digital pins and adjust the voltage value on the analog pins configured as input. Pins configured as outputs also show the average value, useful for evaluating the functioning of PWM outputs.

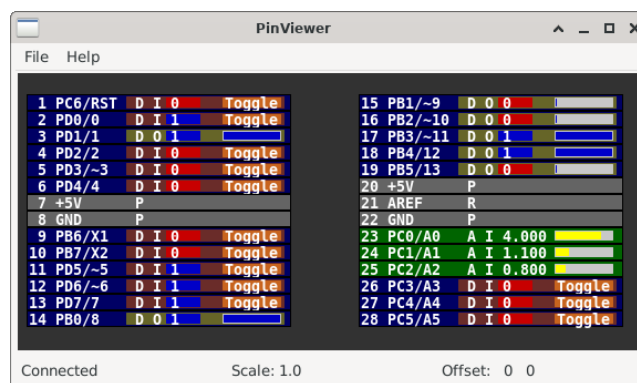

Chapter 8

Oscilloscope

The PICSimLab has a basic two-channel oscilloscope that can be used to view the signal on any pin of the microcontroller. The oscilloscope can be accessed through the “Modules->Oscilloscope” menu.

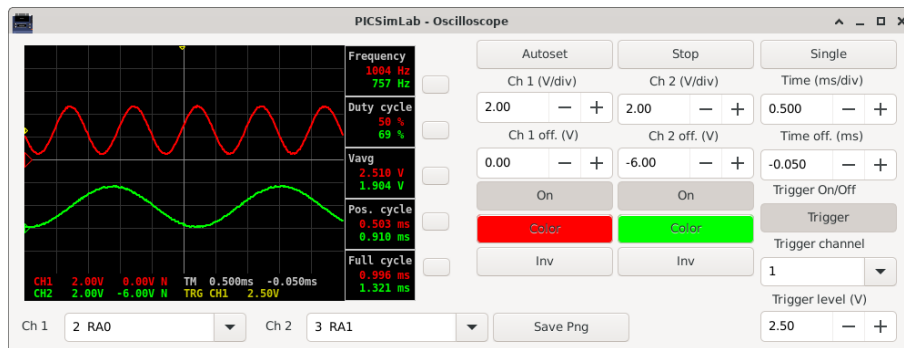

The oscilloscope supports up to 4 simultaneous measurements of the type:

- Vmax
- Vmin
- Vavg
- Vrms
- Frequency
- Duty cycle
- Pos. cycle
- Neg. cycle
- Full cycle

Chapter 9

Spare Parts

The PICSimLab has a window that allows the connection of spare parts to the micro-controller, it can be accessed through the menu “ Modules-> Spare parts ”.

The main window has the menu with the following functions:

- File
 - New configuration - Clear the spare parts window
 - Save configuration - Saves the current settings of the spare parts into .pcf file
 - Load configuration - Loads the settings from .pcf file
 - Save pin alias - Saves the current pin alias to .ppa text file
 - Load pin alias - Loads the pin alias from .ppa file
- Edit
 - Clear pin alias - Clear the pin alias
 - Toggle pin alias - Enable/Disable pin alias use
 - Edit pin alias - Open current pin alias .ppa file in text editor
 - Reload pin alias - Reload the current .ppa pin alias file (need after edit .ppa file)
 - Zoom in - Increase draw scale
 - Zoom out - Decrease draw scale
- Inputs
 - ADXL345 (Accel) - Adds a I2C/SPI accelerometer (only raw values)
 - BMP180 (Pressure I2C) - Adds a I2C pressure and temperature sensor
 - BMP280 (Pressure I2C) - Adds a I2C/SPI pressure and temperature sensor
 - DHT11 (Temp. Hum.) - Adds a humidity and temperature sensor

- DHT22 (Temp. Hum.) - Adds a humidity and temperature sensor
 - DS1621 (Temperature I2C) - Adds a I2C temperature sensor
 - DS18B20 (Temperature) - Adds a 1-Wire temperature sensor
 - Encoder - Adds a rotary quadrature encoder with push button
 - FM50 (Temperature) - Adds a analog temperature sensor
 - Fixed Voltage - Adds a analog fixed voltage reference
 - Gamepad - Adds a gamepad
 - Gamepad (Analogic) - Adds a gamepad with one analogic output
 - HX711 (Load Cell Amp) - Adds a Load Cell with HX711 amplifier
 - Keypad - Adds one matrix keypad
 - LDR - Adds a light dependent resistor
 - LM35 (Temperature) - Adds a analog temperature sensor
 - MPU6050 - Adds a accelerometer and gyroscope (only raw values)
 - Potentiometers - Adds 4 potentiometers
 - Potentiometers (Rotary) - Adds 4 rotary potentiometers
 - Push Buttons - Adds 8 push buttons
 - Push Buttons (Analogic) - Adds 8 push buttons with analog output
 - SHT3X - Adds a analog temperature and humidity sensor
 - Switches - Adds eight switches
 - Ultrasonic HC-SR04 - Adds a ultrasonic range sensor
- Outputs
 - 7 Segments Display - Adds four multiplexed (or single) 7 segments displays
 - 7 Segments Display (w/dec) - Adds four multiplexed 7 segments displays with decoder
 - Buzzer - Adds a active/passive buzzer
 - DC Motor - Adds a DC motor with H-bridge and quadrature encoder
 - LCD hd44780 - Adds a text display hd44780
 - LCD hd44780 I2C - Adds a text display hd44780 connect to one PCF8574 I2C converter
 - LCD ili9340 - Adds a color graphic display ili9340 with touchscreen
 - LCD pcd8544 - Adds a monochrome graphic display pcd8544 (Nokia 5110)
 - LCD pcf8833 - Adds a color graphic display pcf8833
 - LCD ssd1306 - Adds a monochrome graphic display ssd1306
 - LED Matrix - Adds a 8x8 LED matrix with MAX72xx controller

- LEDs - Adds 8 red LEDs
- RGB LED - Adds one RGB LED
- RGB LED WS2812B - Adds one or multiple addressable RGB LED
- Servo Motor - Adds a servo motor
- Step Motor - Adds a step motor
- Others
 - ETH w5500 - Adds a ethernet shield w5500
 - IO 74xx573 - Adds a 74xx573 octal latch
 - IO 74xx595 - Adds a 74xx595 SIPO 8 bit shift register
 - IO MCP23S17 - Adds a MCP23S17 serial SPI IO expander
 - IO MM74C922 - Adds a MM74C922 key encoder
 - IO PCF8574 - Adds a PCF8574 serial I2C IO expander
 - IO UART - Adds a UART serial port
 - Jumper Wires - Adds sixteen jumper wires
 - MEM 24CXXX - Adds a 24CXXX serial I2C EEPROM memory
 - RTC ds1307 - Adds a ds1307 real time clock
 - RTC pfc8563 - Adds a pfc8563 real time clock
 - SD Card - Adds a SD card shield
 - Temperature System - Adds a temperature control system
- Virtual
 - D. Transfer Function - Adds a discrete transfer function mathematical model
 - IO Virtual term - Adds a virtual serial terminal
 - Signal Generator - Adds a virtual signal generator
 - Text Box - Adds a static text box
 - VCD Dump - Adds a digital value file dump recorder
 - VCD Dump (Analogic) - Adds a analog value file dump recorder
 - VCD Play - Adds a digital value file dump player
- Help
 - Contents - Open Help window
 - About - Show message about author and version

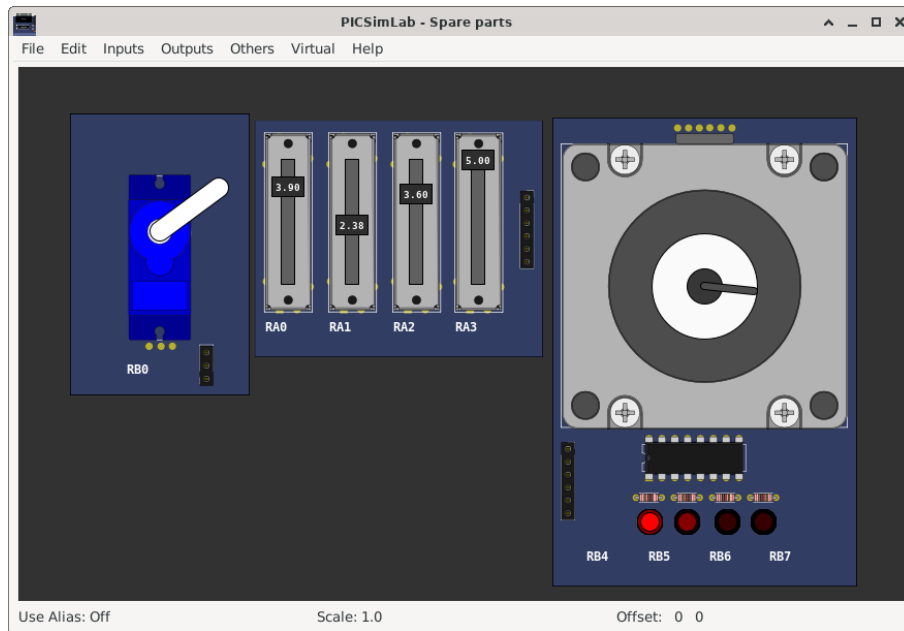

After adding the part, with a right click of the mouse you can access the options menu of the part with the options:

- Properties - Opens the connection settings window
- Move - Unlocks the part to move
- Rotate - Change the orientation of part
- Delete - Remove part
- Help - Open Help window of part
- About - Show message about author and version of part

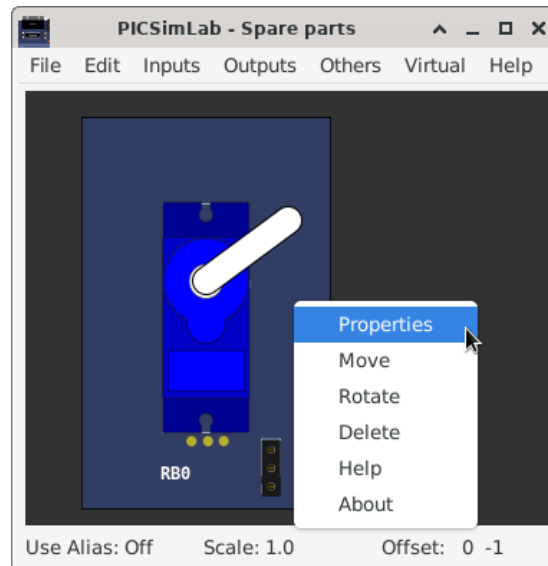

9.1 Pin Alias

The pin alias support allows the user to place custom names on the pins making it easy to identify according to the project.

When off the normal names are shown:

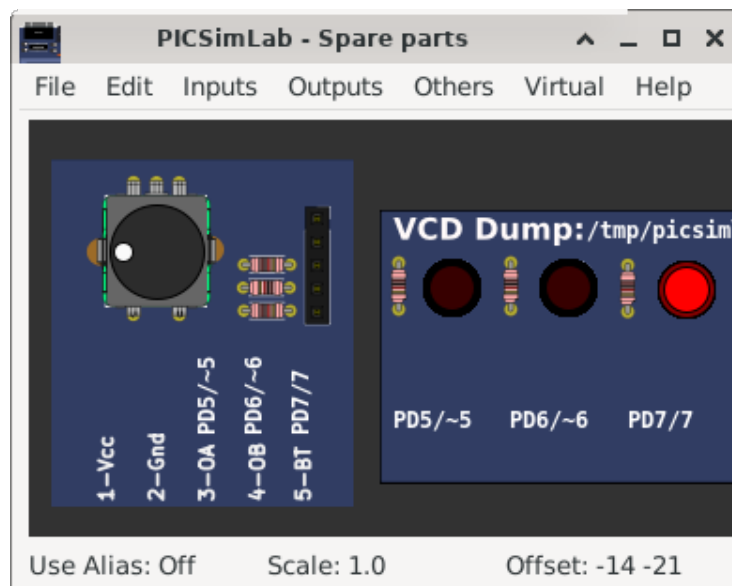

When on the alias names are shown:



To use:

1. active the menu "Edit->Clear pin alias" to reset the pin alias file
2. active the menu "Edit->Edit pin alias" to open pin alias file, change the names, save and close.
3. active the menu "Edit->Reload pin alias" to load new alias
4. active the menu "Edit->Toggle pin alias" to show new alias

9.2 Inputs

9.2.1 ADXL345 (Accel)

This part is ADXL345 accelerometer with I2C/SPI interface. Only raw values are available.

To select SPI mode put low level in CS pin. In I2C mode (CS pin high), the address is 0x1D when SDO is NC or high and 0x53 when SDO pin is held in low.

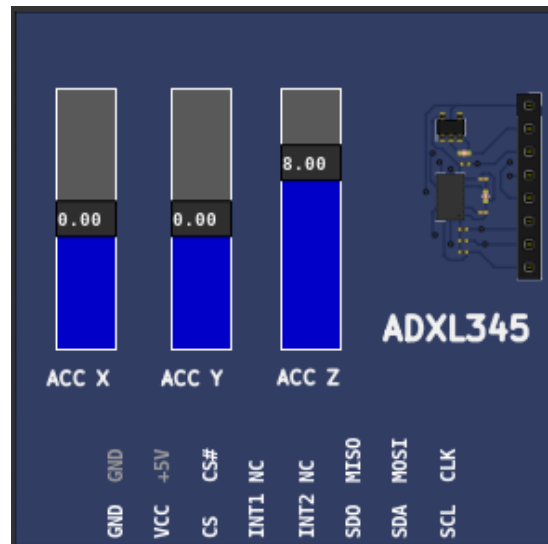

[Examples](#)

[Datasheet](#)

9.2.2 BMP180 (Pressure I2C)

This part is BMP180 I2C pressure and temperature sensor (address 0x77). The temperature range is -40 to 85 °C and the pressure range is 300 hPa to 1100 hPa.

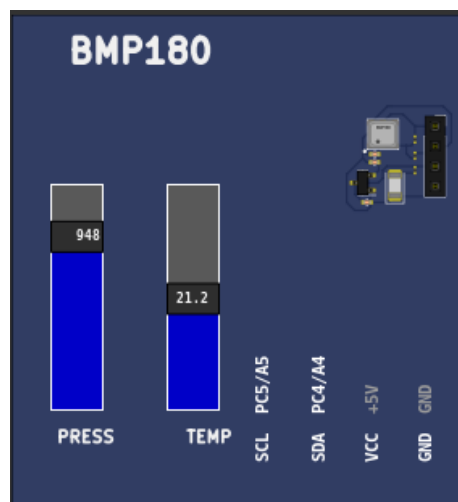

[Examples](#)

[Datasheet](#)

9.2.3 BMP280 (Pressure I2C)

This part is BMP280 I2C/SPI pressure and temperature sensor. The temperature range is -40 to 85 °C and the pressure range is 300 hPa to 1100 hPa.

To select SPI mode put low level in CSB pin. In I2C mode (CSB pin high), the address is 0x77 when SDO is NC or high and 0x76 when SDO pin is held in low.

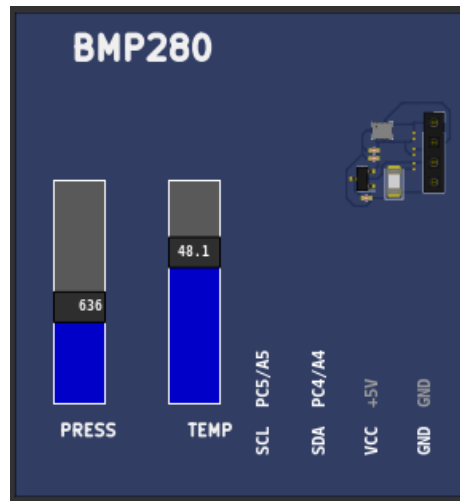

[Examples](#)

[Datasheet](#)

9.2.4 DHT11 (Temp. Hum.)

This part is DHT11 digital temperature and humidity sensor. The temperature range is 0 to 50 °C and the relative humidity range is 20 to 80 %.

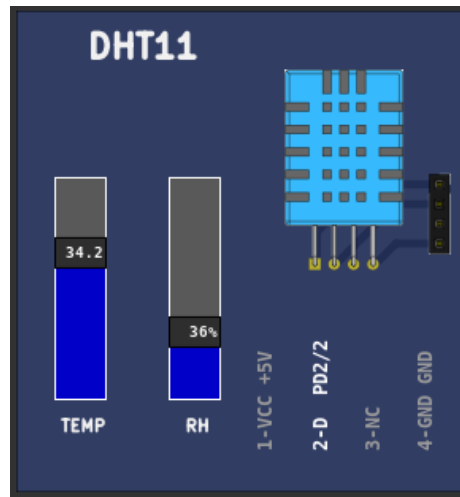

[Examples](#)

[Datasheet](#)

9.2.5 DHT22 (Temp. Hum.)

This part is DHT22 (AM2302) digital temperature and humidity sensor. The temperature range is -40 to 80 °C and the relative humidity range is 0 to 100 %.

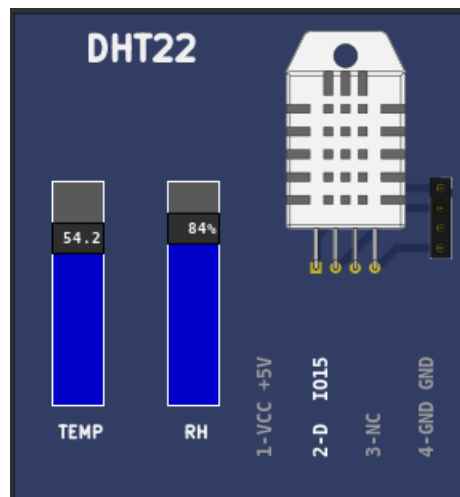

[Examples](#)

[Datasheet](#)

9.2.6 DS1621 (Temperature I2C)

This part is DS1621 I2C temperature sensor. The measurement range is -55 to 125 °C. The I2C address range is 0x48 to 0x4F. If pins A2, A1 and A0 are not connect (NC) the default address is 0x48.

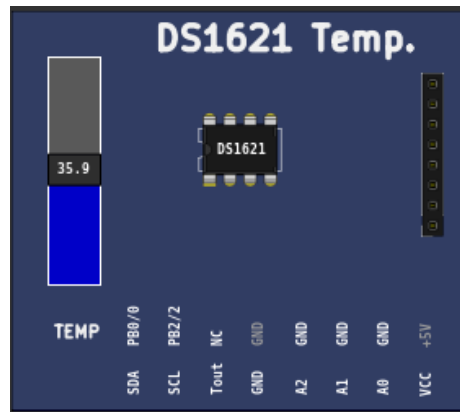

[Examples](#)

[Datasheet](#)

9.2.7 DS18B20 (Temperature)

This part is DS18B20 1-Wire temperature sensor. The measurement range is -40 to 80 °C.



[Examples](#)

[Datasheet](#)

9.2.8 Encoder

This part is a rotary quadrature encoder (Ky-40) with push button. The output is twenty pulses per revolution.

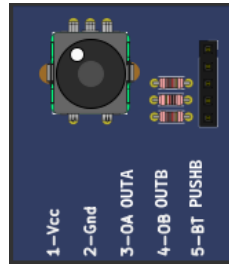
[Examples](#)[Datasheet](#)

9.2.9 FM50 (Temperature)

This part is FM50 analog temperature sensor. The measurement range is -40 to 125 °C and voltage output is $10\text{mV}/^\circ\text{C} + 500\text{mV}$.

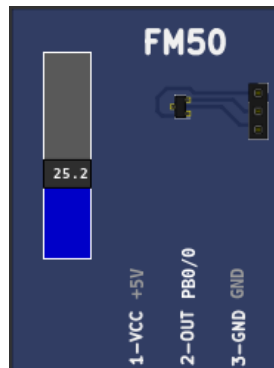
[Examples](#)[Datasheet](#)

9.2.10 Fixed Voltage

This part is analog fixed voltage reference. The value range is 0 to 5V.



Examples

9.2.11 Gamepad

This part is a gamepad with two analog axis and 7 push buttons.

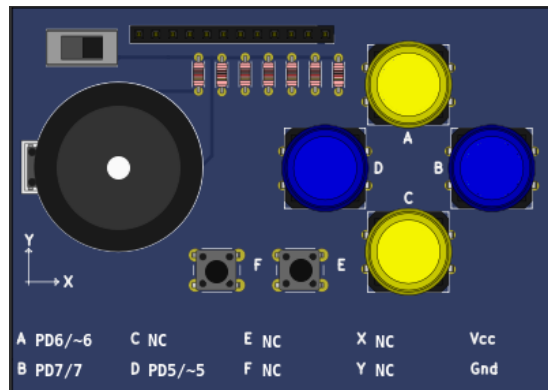

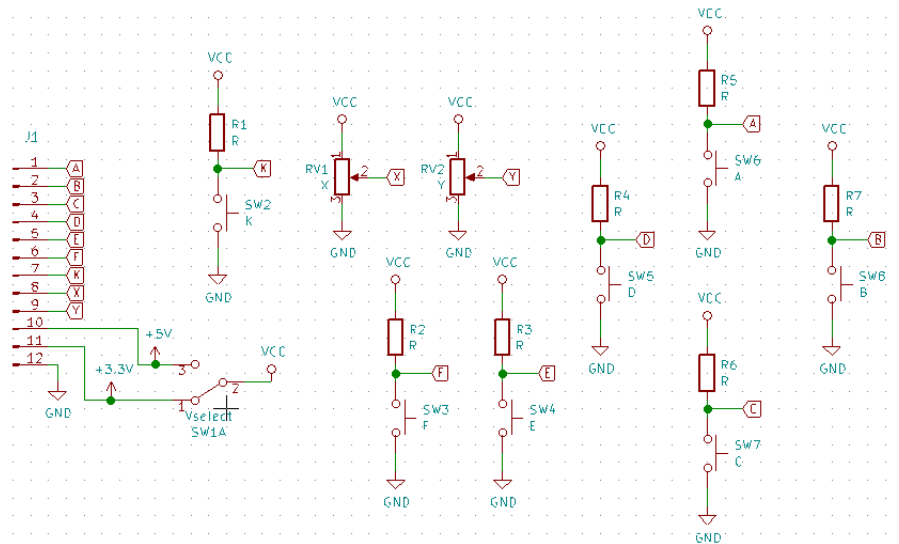

The gamepad can be controlled by keyboards keys:

- X axis - keys 'A' and 'D'
- Y axis - keys 'W' and 'S'
- Button A - key 'I'
- Button B - key 'L'
- Button C - key 'K'
- Button D - key 'J'
- Button E - key 'E'
- Button F - key 'O'
- Button K - key 'R'

Examples

9.2.12 Gamepad (Analogic)

This part is a gamepad with 5 push buttons and one analogic output.

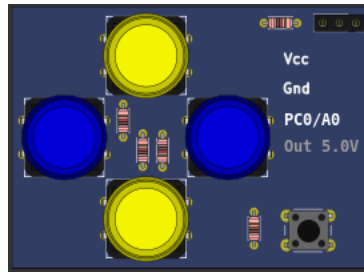

The gamepad can be controlled by keyboards keys:

- Button A - key 'L'
- Button B - key 'I'
- Button C - key 'K'
- Button D - key 'J'
- Button E - key 'O'

[Examples](#)

9.2.13 HX711 (Load Cell Amp)

This part is a 100Kg Load Cell with HX711 amplifier.

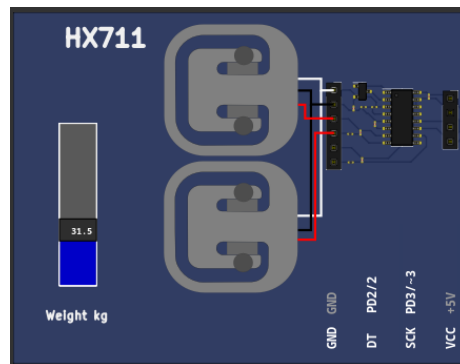

[Examples](#)

[Datasheet](#)

9.2.14 Keypad

It is a matrix keyboard configurable to 4x3 , 4x4 or 2x5 rows/columns.



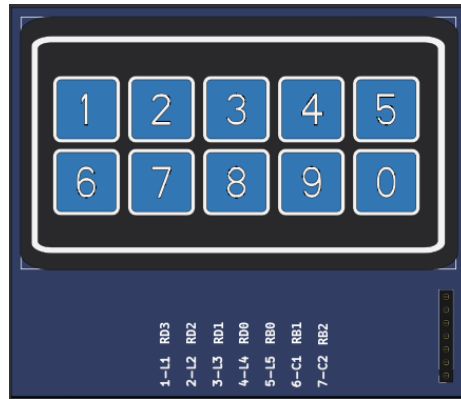

Examples

9.2.15 LDR

This part is light dependent resistor (LDR) connected in series with one 10K resistor. The analog output of the voltage divider is applied to one voltage follower and can be read directly from pin A0. The analog value from voltage follower is compared with one voltage threshold, the digital output of comparator and can be read directly from pin D0.

LDR Characteristics	Value
Gamma value at 100-10Lux	0.7
Light Resistance at 10Lux (25°C)	20KΩ

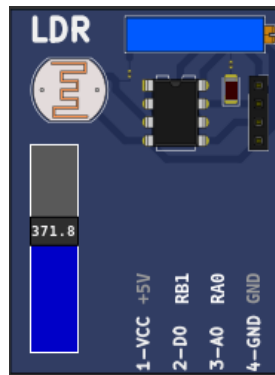

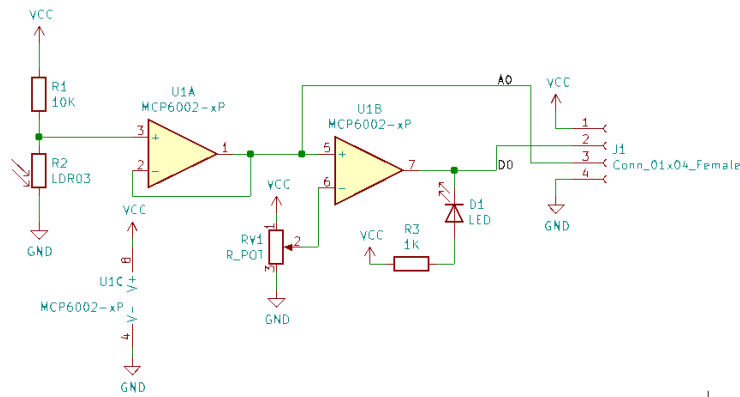

[Examples](#)

[Datasheet](#)

9.2.16 LM35 (Temperature)

This part is LM35 analog temperature sensor. The measurement range is 2 to 150 °C and voltage output is 10mV/°C.

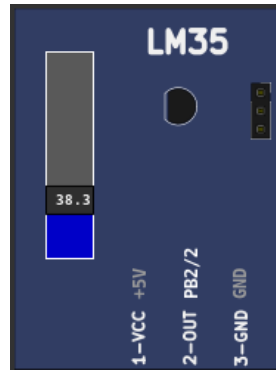

[Examples](#)

[Datasheet](#)

9.2.17 MPU6050

This part is MPU6050 accelerometer and gyroscope with I2C interface. Only raw values are available, DMP is not supported.

The I2C address is 0x68 when AD0 is NC or low and 0x69 when AD0 pin is held in high.

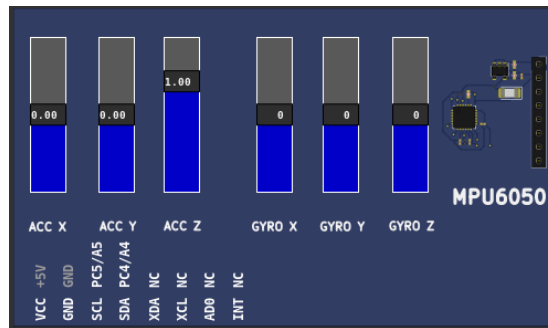

[Examples](#)

[Datasheet](#)

9.2.18 Potentiometers

This part is formed by 4 potentiometers connected between 0 and 5 volts, the output is connected to the cursor and varies within this voltage range.

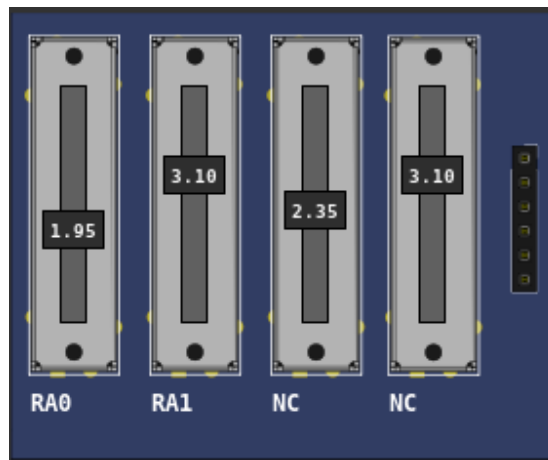

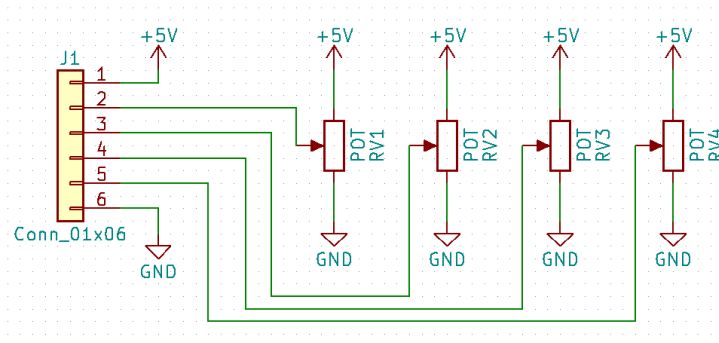

Examples

9.2.19 Potentiometers (Rotary)

This part is formed by 4 rotary potentiometers connected between 0 and 5 volts, the output is connected to the cursor and varies within this voltage range.

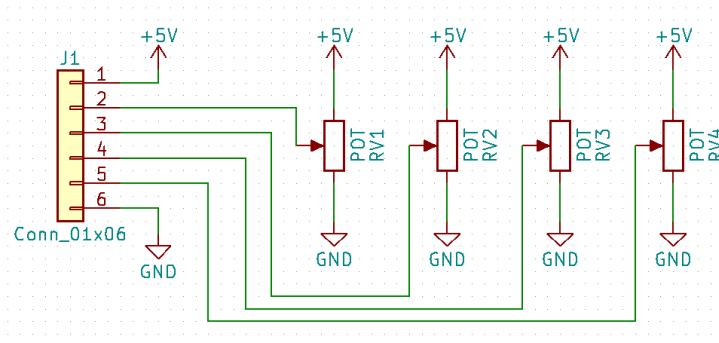
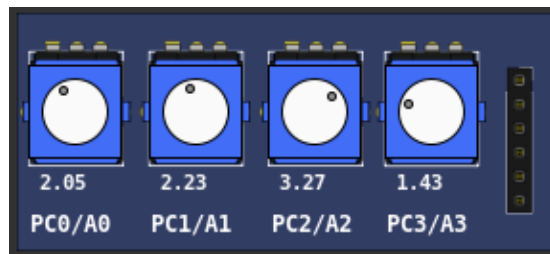

Examples

9.2.20 Push Buttons

This part consists of 8 push buttons. The output active state can be configurable. The buttons have activation bounce effect emulation.

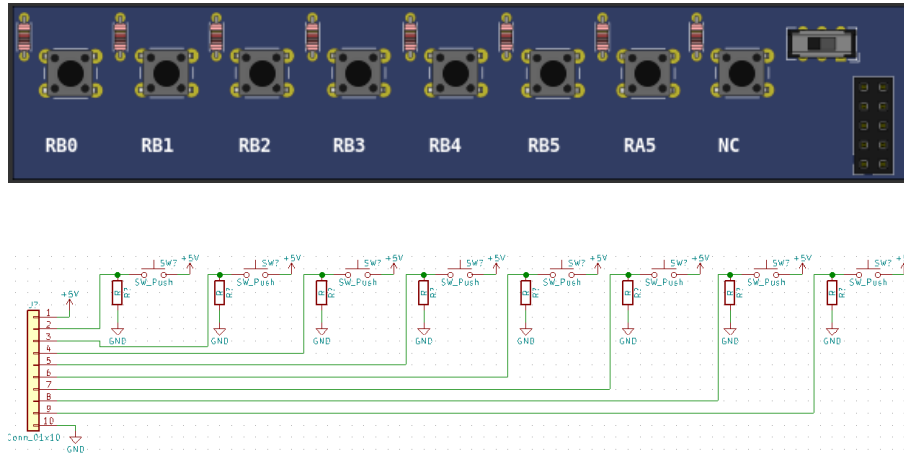

Examples

9.2.21 Push Buttons (Analogic)

This part consists of 8 push buttons connected in a resistive ladder.

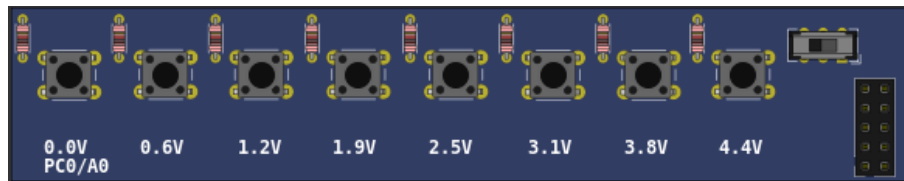

Examples

9.2.22 SHT3X (Temp. Hum.)

This part is SHT3X analog temperature and humidity sensor. The temperature range is -40 to 125 °C and voltage output is $22.85\text{mV}/^\circ\text{C} + 1.53\text{V}$. The relative humidity range is 0 to 100 % and voltage output is $40\text{mV}/\% + 500\text{mV}$.

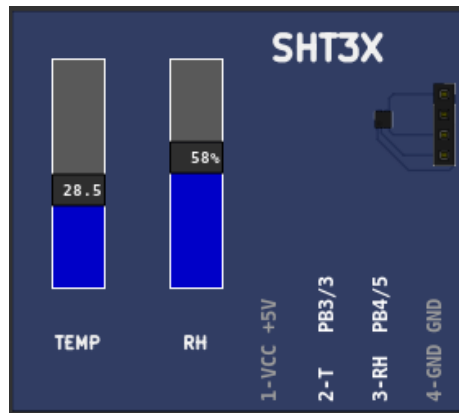

[Examples](#)

[Datasheet](#)

9.2.23 Switches

This part consists of 8 switches with on or off position (0 or 1). The switches have activation bounce effect emulation.

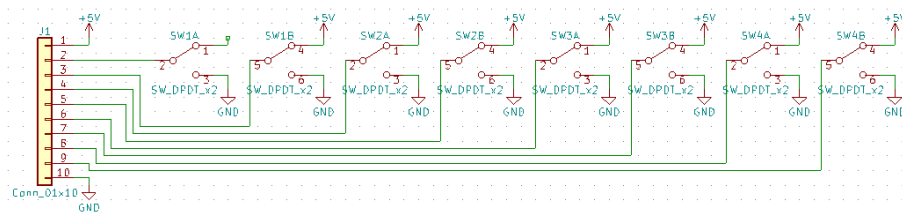

[Examples](#)

9.2.24 Ultrasonic HC-SR04

This part is ultrasonic range meter sensor.



[Examples](#)

[Datasheet](#)

9.3 Outputs

9.3.1 7 Segments Display

This part can be configured as four multiplexed or one single 7 segments display.

Four Multiplexed



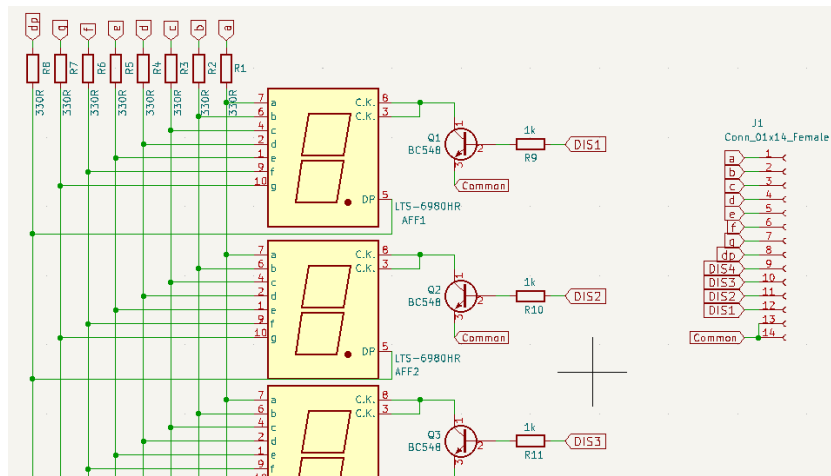

Single Display

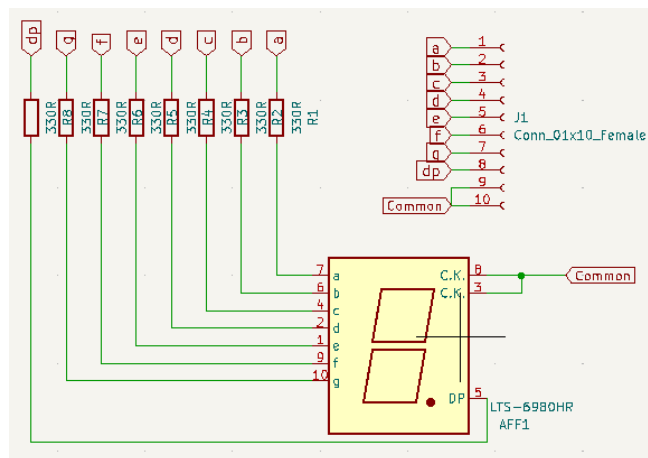
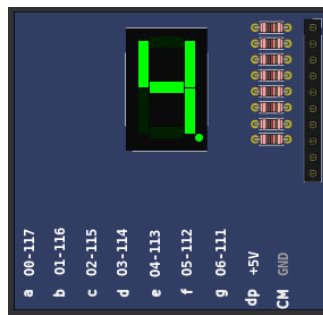

Examples

9.3.2 7 Segments Display (Decoder)

This is a four multiplexed 7 segments displays with BCD to 7 segments decoder (CD4511).

Four Multiplexed

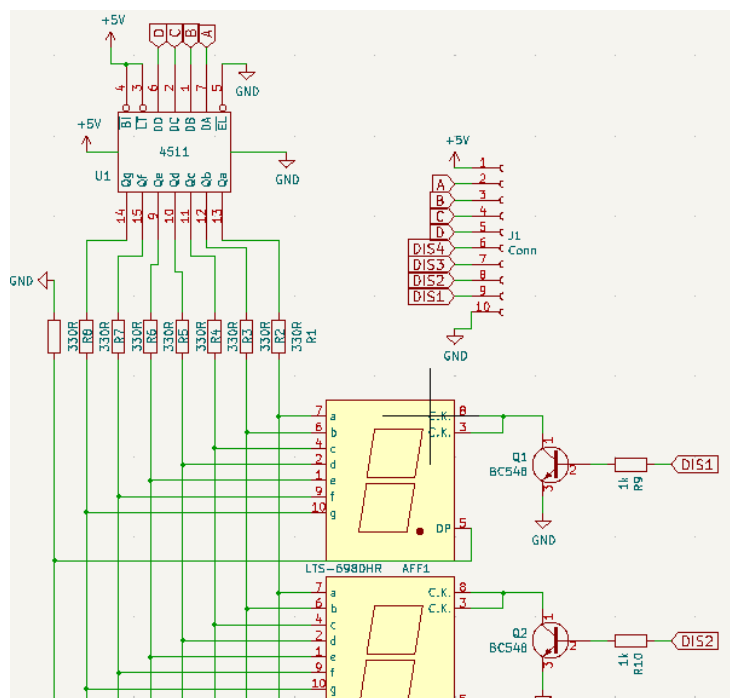
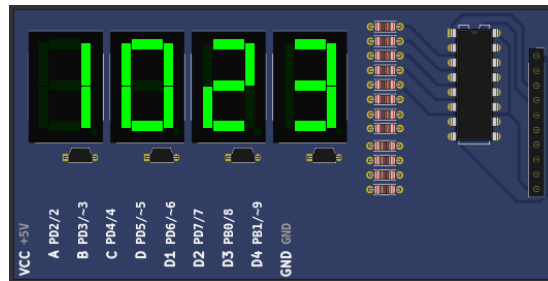

Four with Latch

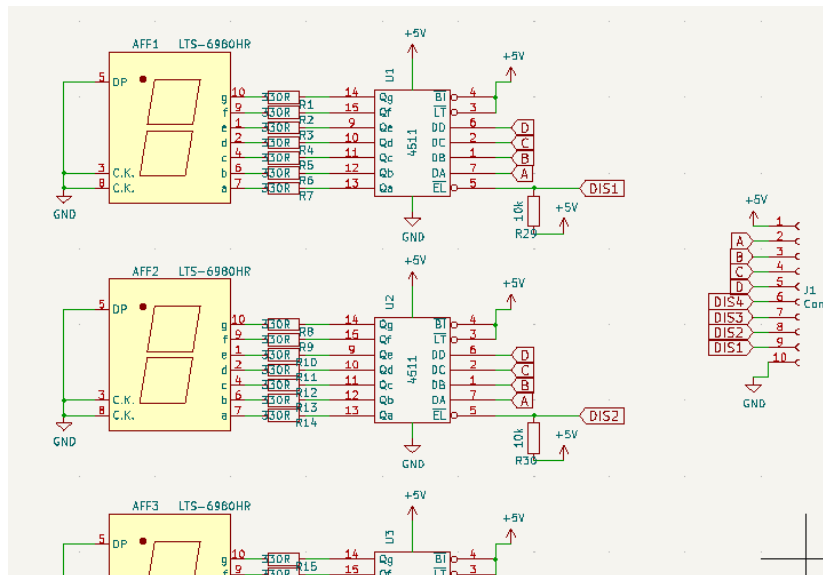
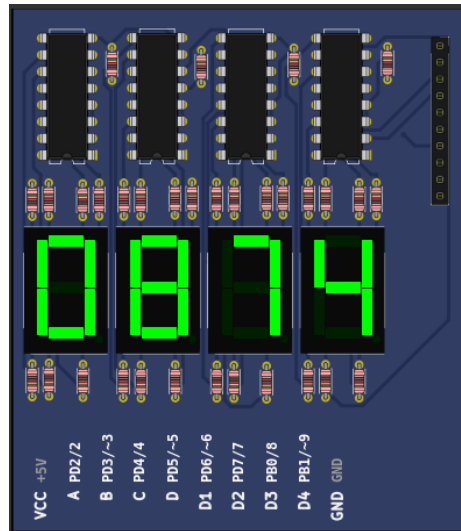

Examples

9.3.3 Buzzer

This is a active/passive buzzer. The buzzer has 3 operating modes:

- **Active:** When powered, the buzzer emits a frequency of 440Hz.
- **Passive:** In this mode the values read from the input pin are sent directly to the sound card, this mode only works well if the simulation is in real time.
- **Tone:** This second passive mode measures the frequency on the input and updates the frequency of the buzzer every 100ms, its accuracy is less than the normal passive mode but it works better when the simulation is not in real time.



Examples

9.3.4 DC Motor

This part is DC motor with H-bridge driver and quadrature encoder.

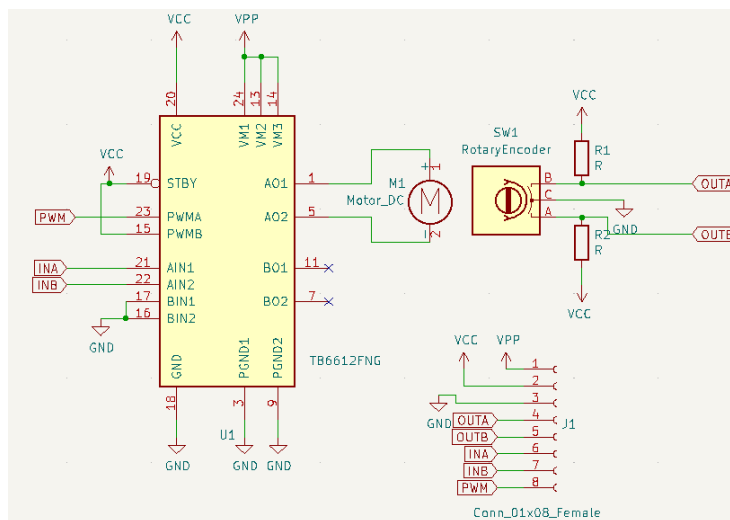

Examples

9.3.5 LCD hd44780

This part is a text display with 2 (or 4) lines by 16 (or 20) columns.

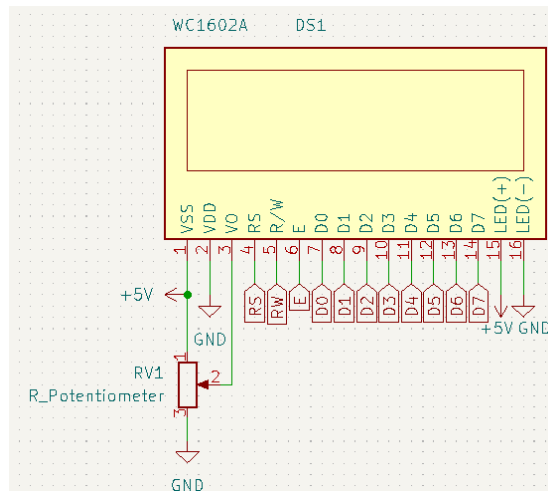





[Examples](#)

[Datasheet](#)

9.3.6 LCD ili9341

This part is a color graphic display with 240x320 pixels with touchscreen (xpt2046 controller). Only 4 SPI mode and 8 bits parallel mode is available.

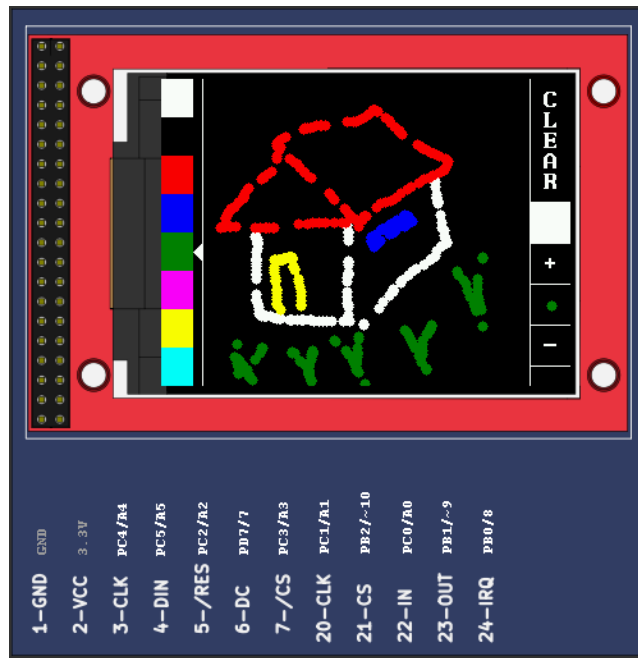

Examples

[Datasheet ILI9341](#)

[Datasheet xpt2046](#)

9.3.7 LCD pcf8833

This part is a color graphic display with 132x132 pixels.



Examples

9.3.8 LCD pcd8544

This part is a monochrome graphic display with 48x84 pixels. (Nokia 5110)

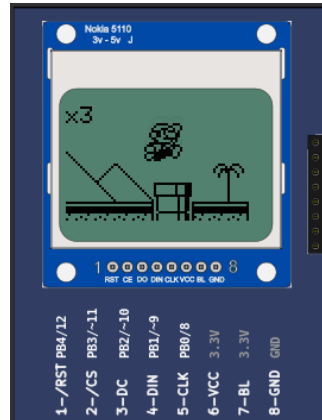

[Examples](#)

[Datasheet](#)

9.3.9 LCD ssd1306

This part is a monochrome oled graphic display with 128x64 pixels. The part suport I2C and 4 SPI serial mode.

In the I2C mode address is 0x3c when DC pin is NC or low and 0x3d when DC pin is held in high.

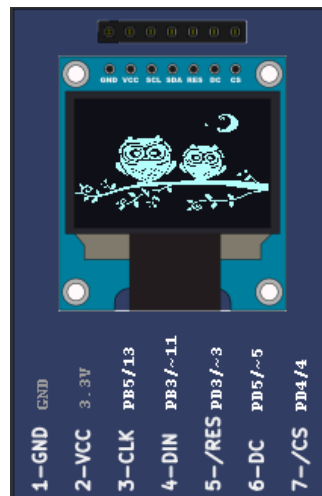

[Examples](#)

[Datasheet](#)

9.3.10 LED Matrix

It is a 8x8 LED matrix with MAX72xx controller.

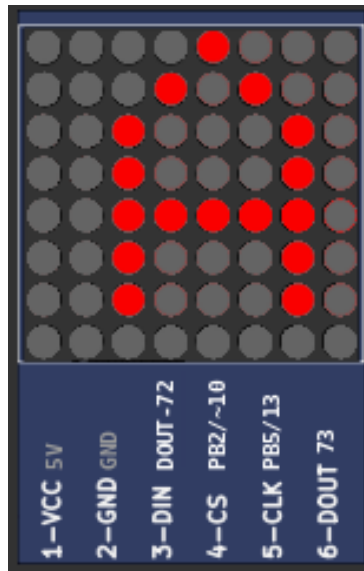

[Examples](#)

9.3.11 LEDs

This part is a bar of 8 independent colored LEDs.

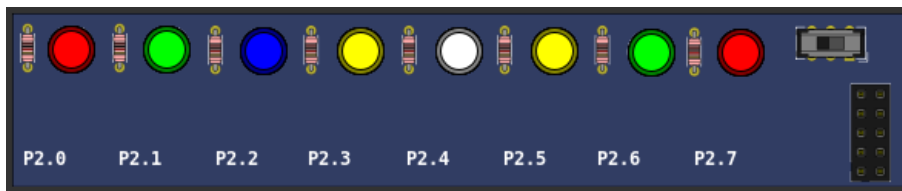

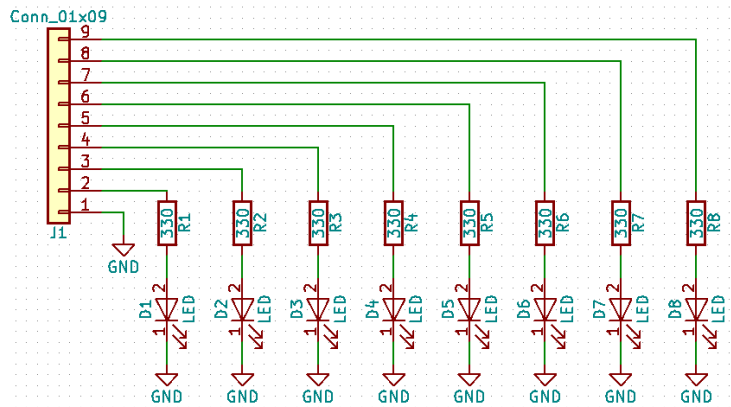

Examples

9.3.12 RGB LED

This part consists of a 4-pin RGB LED. Each color can be triggered independently. Using PWM it is possible to generate several colors by combining the 3 primary colors.

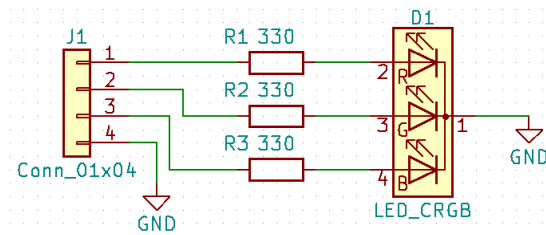
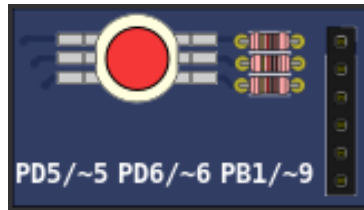

Examples

9.3.13 RGB LED WS2812B

This part consists of a addressable RGB LED WS2812B. It is possible to set the number of rows and columns in the configuration window. The LED can be used with or without diffuser.

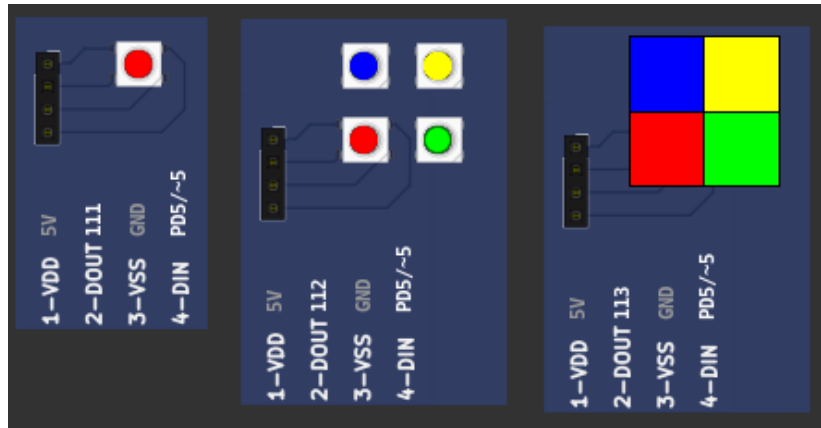

Examples

9.3.14 Servo Motor

The servo motor is a component that must be activated with a pulse of variable width from 1ms to 2ms every 20 ms. A pulse of 1ms positions the servo at -90°, one from 1.5ms to 0° and one from 2ms to 90°.

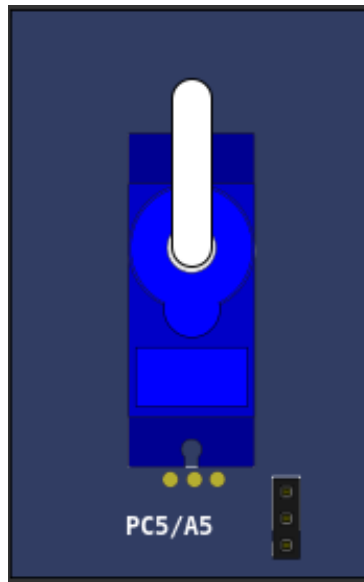

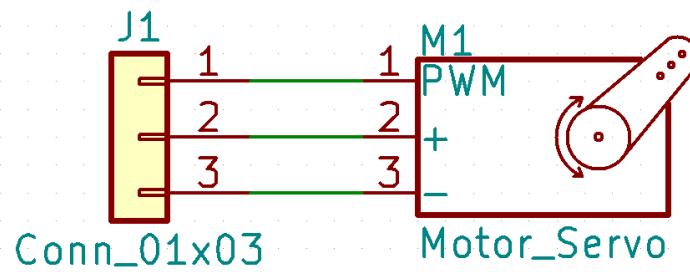

Examples

9.3.15 Step Motor

The stepper motor is a component with 4 coils that must be driven in the correct order to rotate the rotor. Each step of the motor is 1.8°.

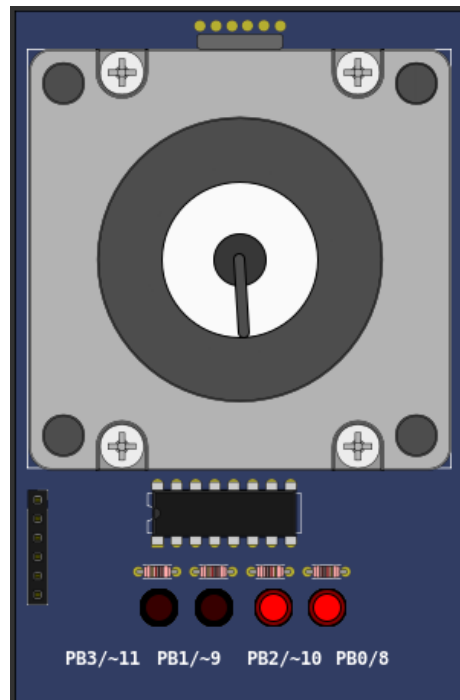

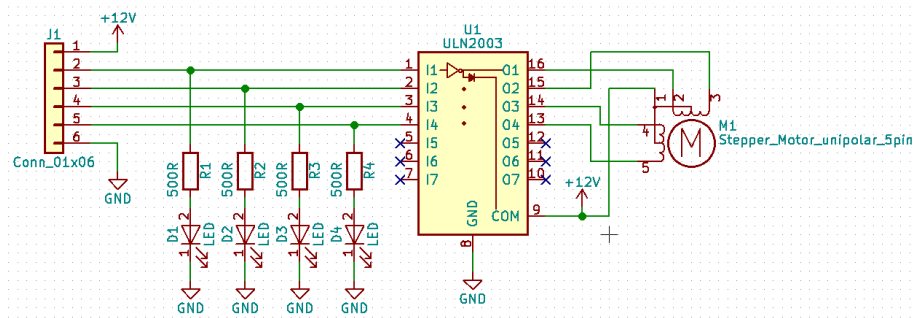

Examples

9.4 Others

9.4.1 ETH w5500

This part is a ethernet shield w5500 with support to 8 sockets simultaneously.

Only TCP/UDP unicast address sockets is supported. DHCP is emulated and return a fake ipv4 address.

All listening ports below 2000 are increased by 2000 to avoid operational system services ports. For example listening on port 80 becomes 2080.

w5500 Status Legend:

1° Letter - Type	2° Letter - Status	3° Letter - Error
C - Closed	C - Closed	B - Bind
T - TCP	I - Initialized	S - Send
U - UDP	L - Listen	R - Receive
M - MACRAW (don't supported)	S - Syn sent	L - Listen
	E - Established	U - Reuse
	W - Close wait	C - Connecting
	U - UDP	D - Shutdown
	M - MACRAW (don't supported)	

Click on connector to toggle link status.

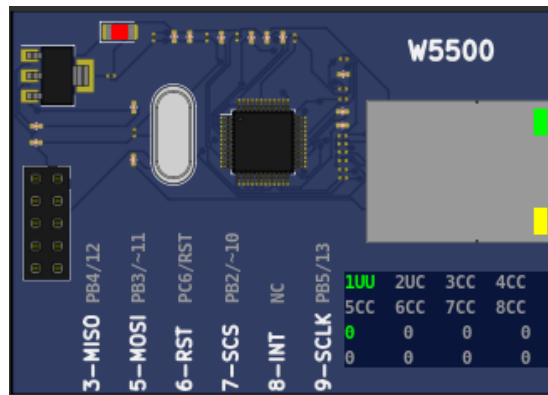

[Examples](#)

[Datasheet](#)

9.4.2 IO 74xx573

This is one 74xx573 octal latch.

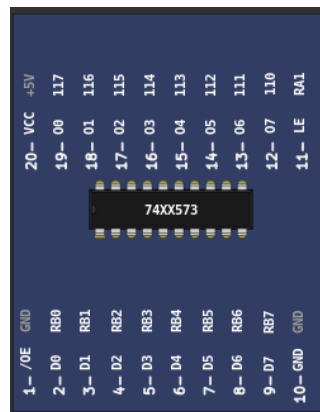

[Examples](#)

9.4.3 IO 74xx595

This is one 74xx595 serial input and parallel output 8 bit shift register.

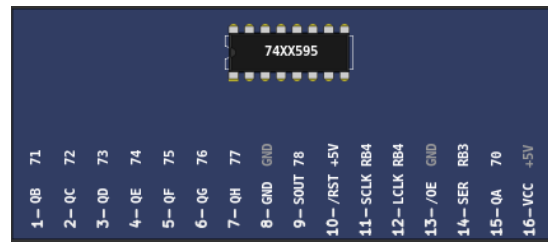

Examples

9.4.4 IO MCP23S17

It is a MCP23S17 serial SPI IO expander part.

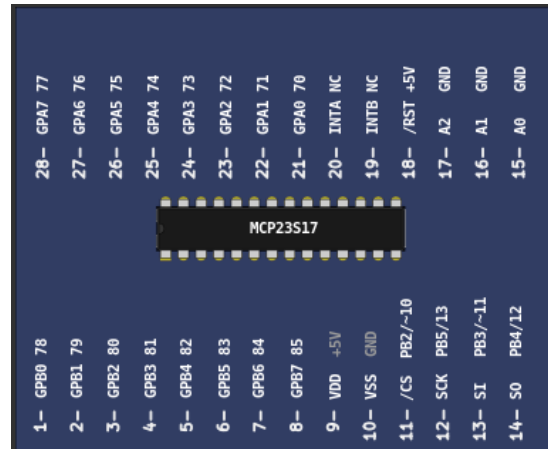

Examples

9.4.5 IO MM74C922

It is a MM74C922 key encoder.

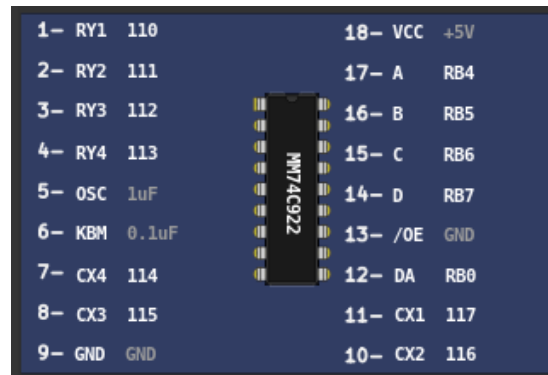

[Examples](#)

[Datasheet](#)

9.4.6 IO PCF8574

It is a PCF8574 serial I2C IO expander (Address 0x20 to 0x27).

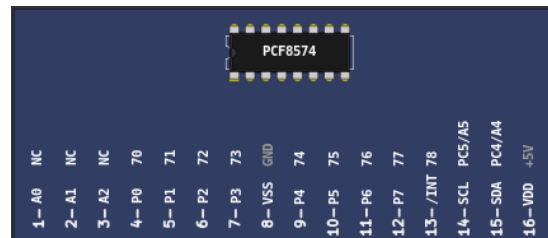

[Examples](#)

[Datasheet](#)

9.4.7 IO UART

This part is a UART serial port. This part connects the hardware/software UART IO pins of microcontroller to one real/virtual PC serial port. To use virtual port is need to install a virtual port software, as described in Chapter: [Serial Communication](#). The serial communication uses the 8N1 format.

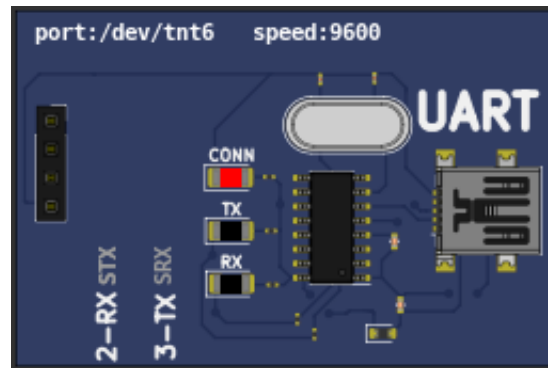

Examples

9.4.8 Jumper Wires

This part are formed by sixteen jumper wires. Each jumper has one input and one output. The jumper input must be connected to one pin output, the jumper output can be connected to multiple pin inputs. The jumper can be used to connect microcontroller pins or make connection between spare parts pins.

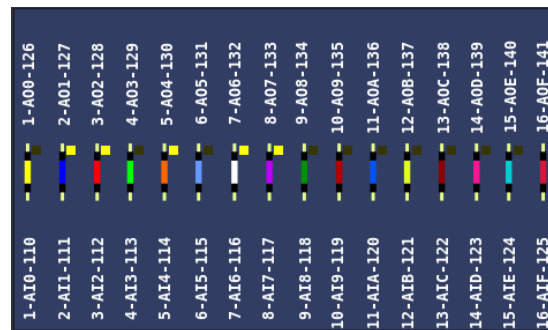

Examples

9.4.9 MEM 24CXXX

It is a 24CXXX serial I2C EEPROM part. There are support to the models 24C04 and 24C512.

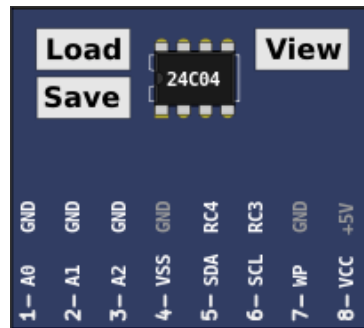

[Examples](#)

[Datasheet 24C04](#)

[Datasheet 24C512](#)

9.4.10 RTC ds1307

This part is a ds1307 real time clock with serial I2C interface (Address 0x68).

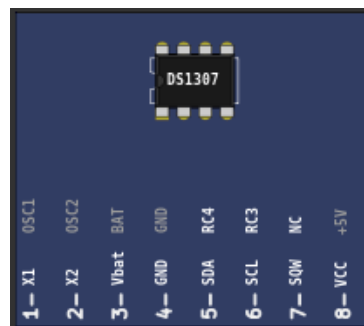

[Examples](#)

[Datasheet](#)

9.4.11 RTC pfc8563

This part is a pfc8563 real time clock with serial I2C interface (Address 0x51).

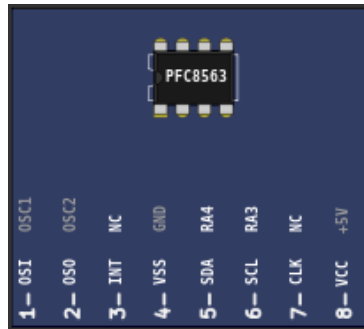

[Examples](#)

[Datasheet](#)

9.4.12 SD Card

This part is a SD Card shield. It's necessary set one sd card file image before use it. (Click on SD card connector to open file dialog)

On Linux one empty image can be created with this command:

```
dd if=/dev/zero of=sd.img bs=1M count=32
```

This empty image can be used with raw SD card access, to work with FAT file system the image need to be formatted before the use. (using [SdFormatter.ino](#) for example)

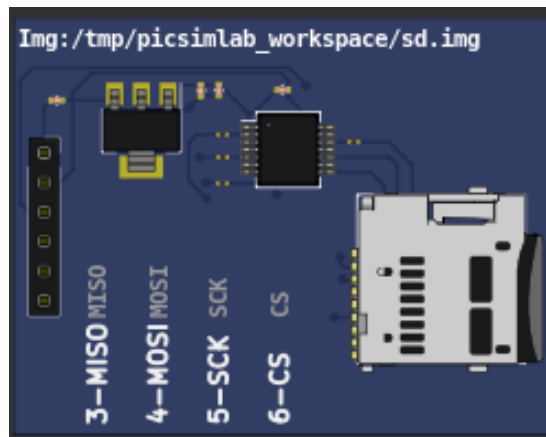

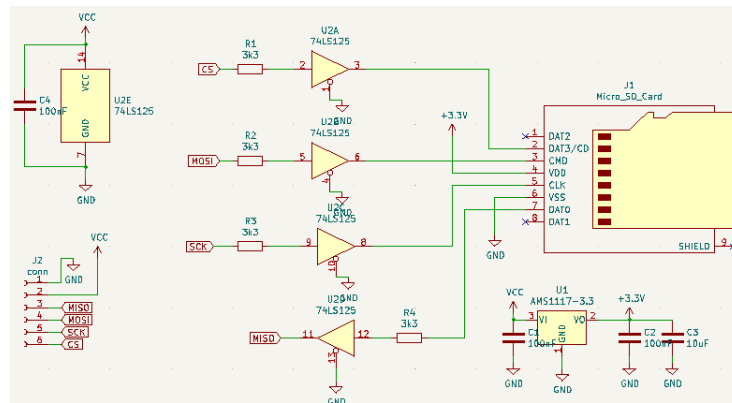

Examples

9.4.13 Temperature System

This part is a temperature control system. The temperature control system consists of a heating resistor, an LM35 temperature sensor, a cooler and an infrared tachometer.

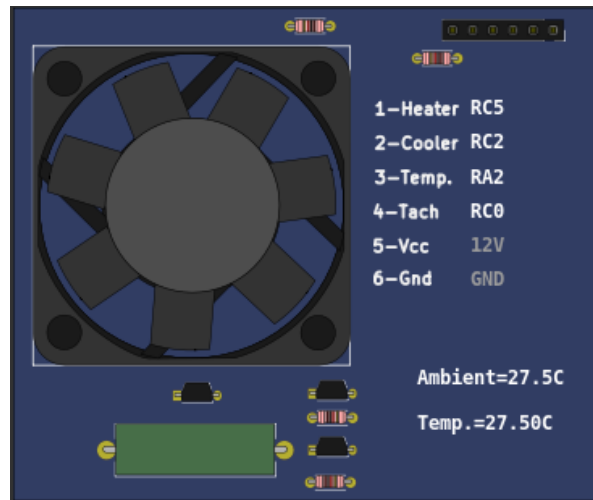

Examples

9.5 Virtual

9.5.1 D. Transfer Function

This is a discrete transfer function mathematical model.

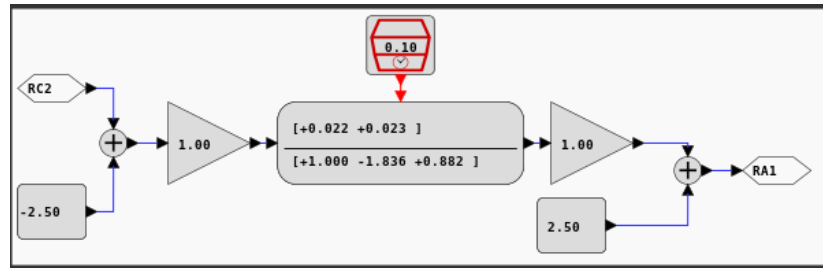

Examples

9.5.2 IO Virtual Term

This part is a virtual serial terminal. This part can be used to read and write RX/TX pins UART signals. To use this part are don't need to use or install one virtual serial ports on computer. Click on terminal picture to open the terminal window. The serial communication uses the 8N1 format.

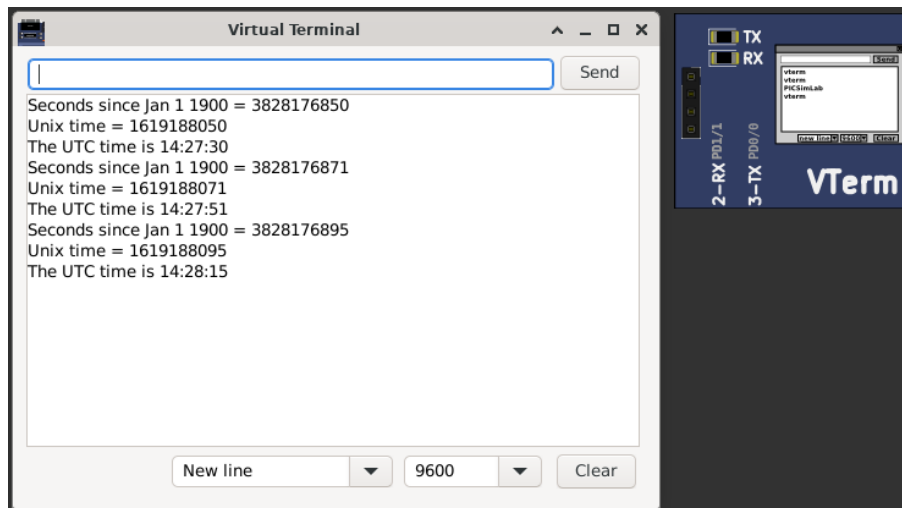

Examples

9.5.3 Signal Generator

This part is a virtual signal generator with support for sine, square and triangular waves generation with amplitude and frequency adjustment.

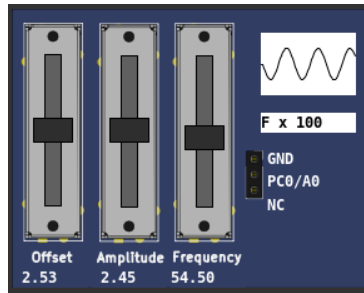

Examples

9.5.4 Text Box

This part is static multiline text box.



Examples

9.5.5 VCD Dump

This part is a digital value file dump (VCD) recorder. The VCD generated file can be visualized with one external viewer like [gtkwave](#) or [pulseview](#).

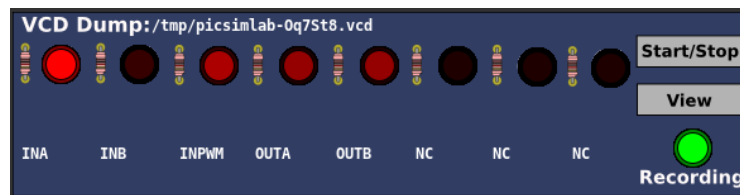

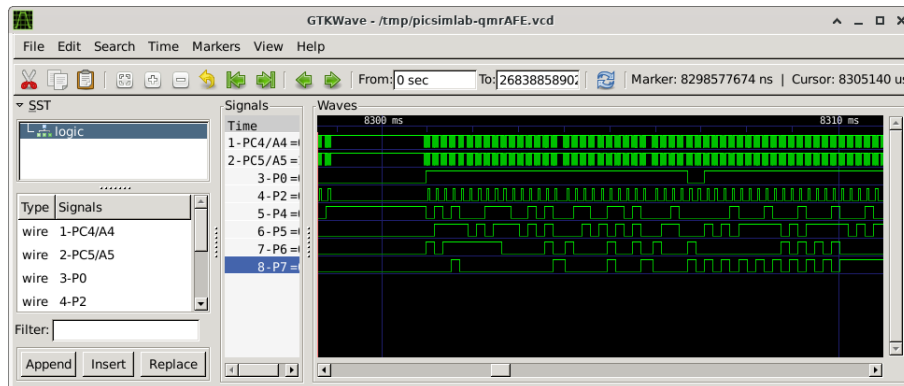

Examples

9.5.6 VCD Dump (Analogic)

This part is a analog value file dump (VCD) recorder. The VCD generated file can be visualized with one external viewer like [gtkwave](#) or [pulseview](#).

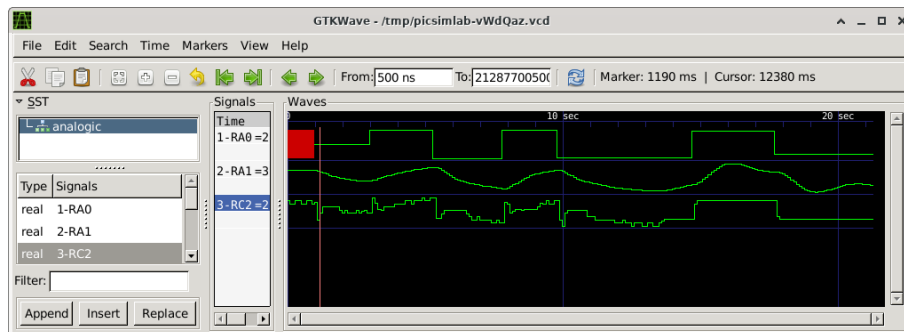
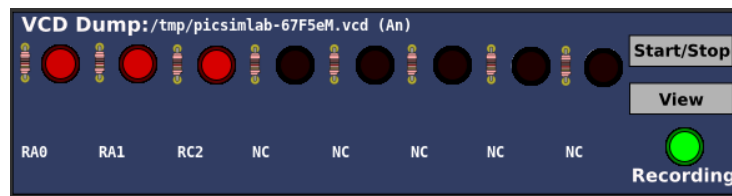

Examples

9.5.7 VCD Play

This part play a VCD file generated from VCD Dump part.

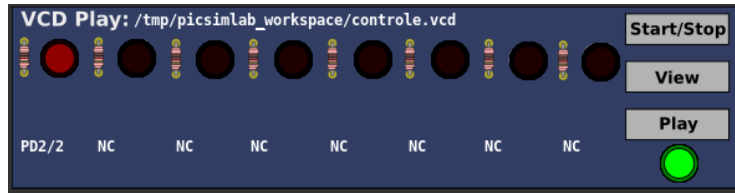

Examples

Chapter 10

Troubleshooting

The simulation in PICSimLab consists of 3 parts:

- The microcontroller program
- Microcontroller simulation (made by [picsim](#) and [simavr](#))
- Simulation of boards and parts

When a problem occurs it is important to detect where it is occurring.

One of the most common problems is the error in the microcontroller program. Before creating an issue, test your code on a real circuit (even partially) to make sure the problem is not there.

Errors in the microcontroller simulation can be detected using code debugging. Any instruction execution or peripheral behavior outside the expected should be reported in the project of simulator used ([picsim](#) or [simavr](#)).

If the problem is not in either of the previous two options, the problem is probably in PICSimLab. A good practice is to send a source code together with a PICSimLab workspace (.pzw file) to open the issue about the problem.

Chapter 11

License

Copyright © 2023 Luis Claudio Gambôa Lopes <lcgamboa@yahoo.com>

This program is free software; you can redistribute it and/or modify it under the terms of the GNU General Public License as published by the Free Software Foundation; either version 2 of the License, or (at your option) any later version.

This program is distributed in the hope that it will be useful, but WITHOUT ANY WARRANTY; without even the implied warranty of MERCHANTABILITY or FITNESS FOR A PARTICULAR PURPOSE. See the GNU General Public License for more details.

You should have received a copy of the GNU General Public License along with this program; if not, write to the Free Software Foundation, Inc., 59 Temple Place, Suite 330, Boston, MA 02111-1307, USA.

Appendix A

Online Simulator

The online version of PICSimLab has the same source code as the desktop version compiled using [Emscripten](#). The online version does not have the Tools menu, support for debugging and serial communication (only for **IO Vterm**).

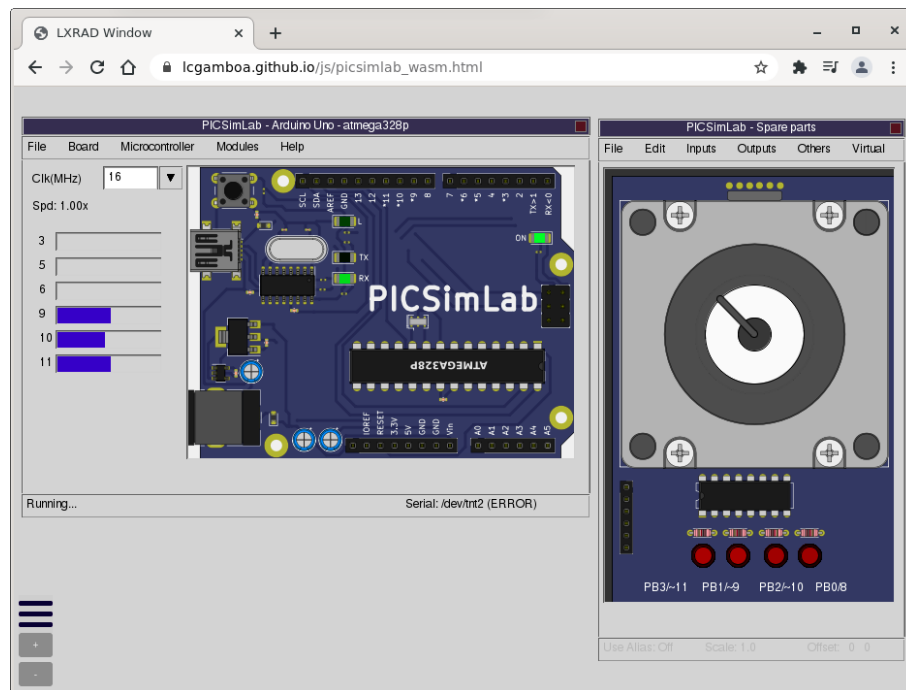

There are three versions generated with Emscripten:

- **WASM with multithread** - Fast speed (50% of desktop version) and worse browser compatibility (currently only tested and work in Chrome and Firefox desktop)

- [WASM](#) - Good speed and good browser compatibility
- [ASM.JS](#) - Slow speed and better browser compatibility

Clicking on the three-bar menu (bottom left) or any loading option in the menus to open the file loading window. Files can be loaded by drag and drop or by the load button.

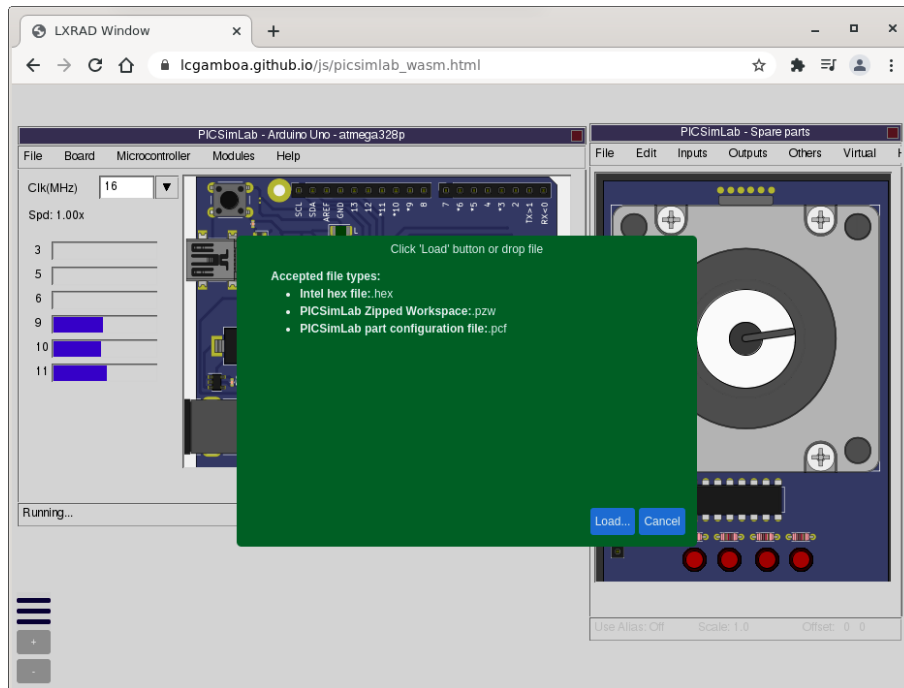

The simulator can also be accessed from the [examples page](#) for online viewing of most examples (View Online link).

Due to the limitations of the online version, it is advisable to use the desktop version which has more resources and higher simulation speed, especially above 8Mhz clocks.

Appendix B

Use with MPLABX

Use with MPLABX to program and Debug

B.1 Installing the Necessary Tools

B.1.1 Install MPLABX IDE and XC8 Compiler

Links for download [MPLABX IDE](#) and [XC8 Compiler](#) installers. Download and install.

For PICSimLab only MPLAB X IDE and 8 bit MCU support needs to be installed.

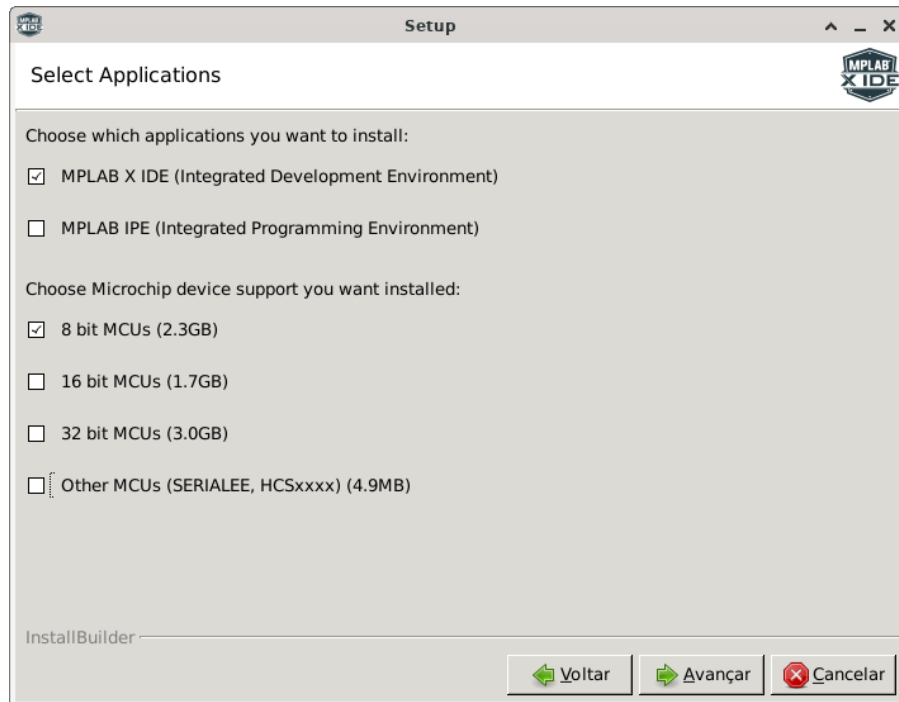

B.1.2 Install PICsimLab

Link for download [PICSimLab](#) installer. Download and install

B.1.3 How to Install PICSimLab MPLABX Debugger plugin

Link for download [PicsimLab MPLABX Debugger plugin \(com-picsim-picsimlab.nbm\)](#)

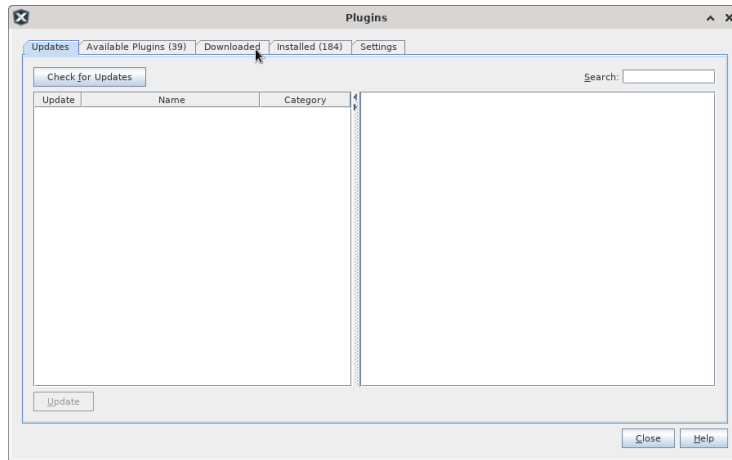
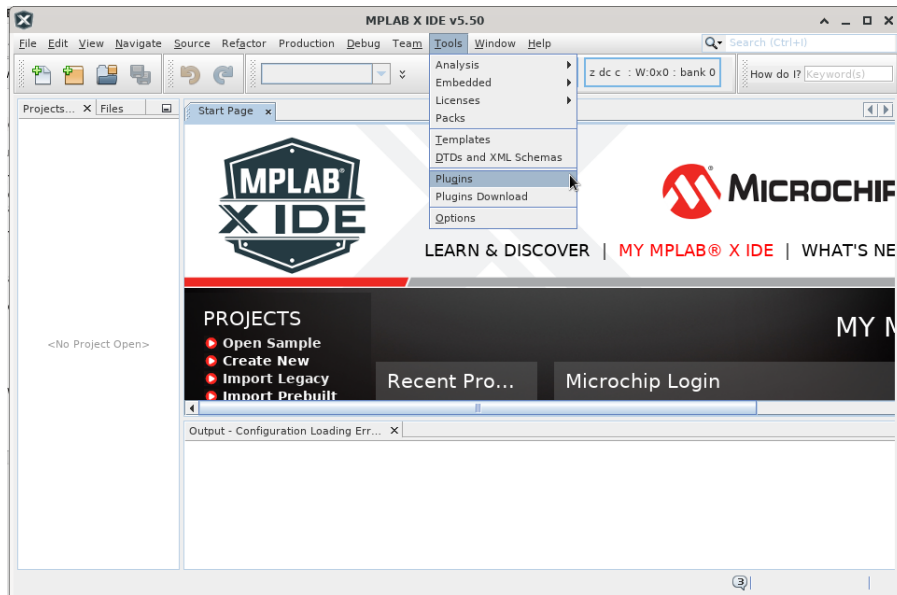

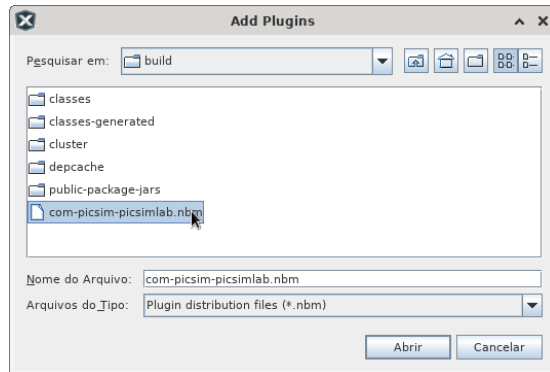
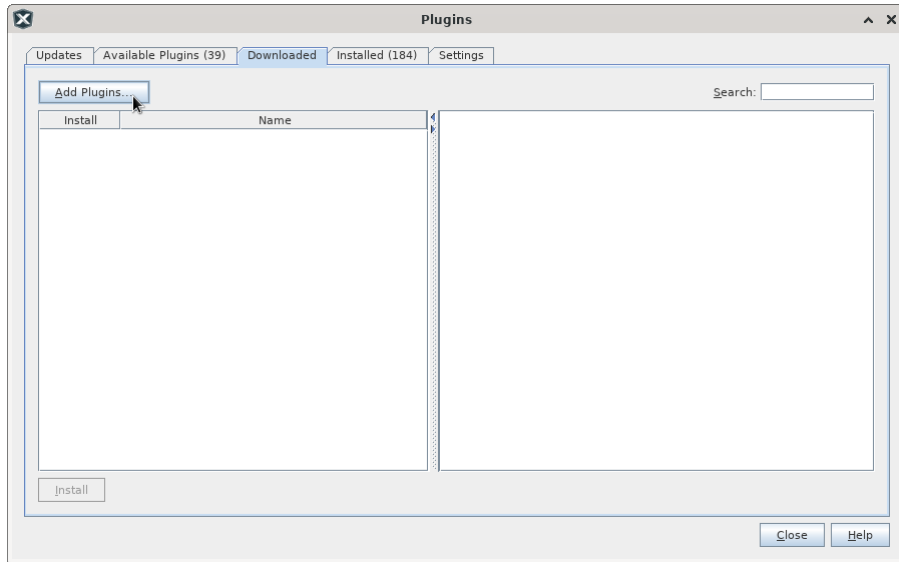

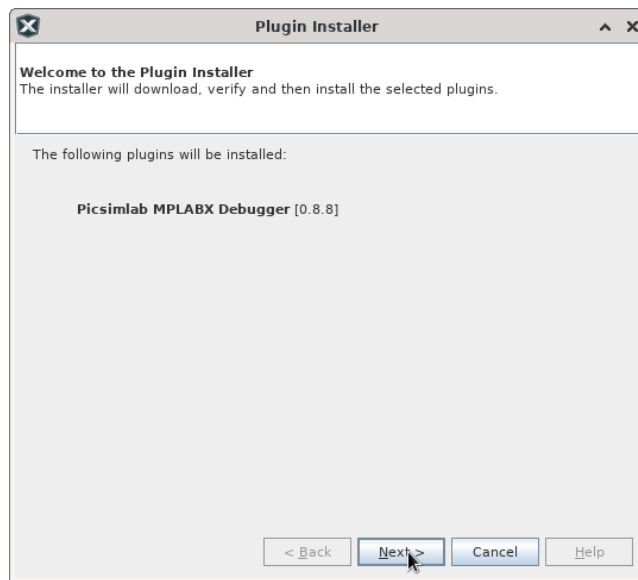
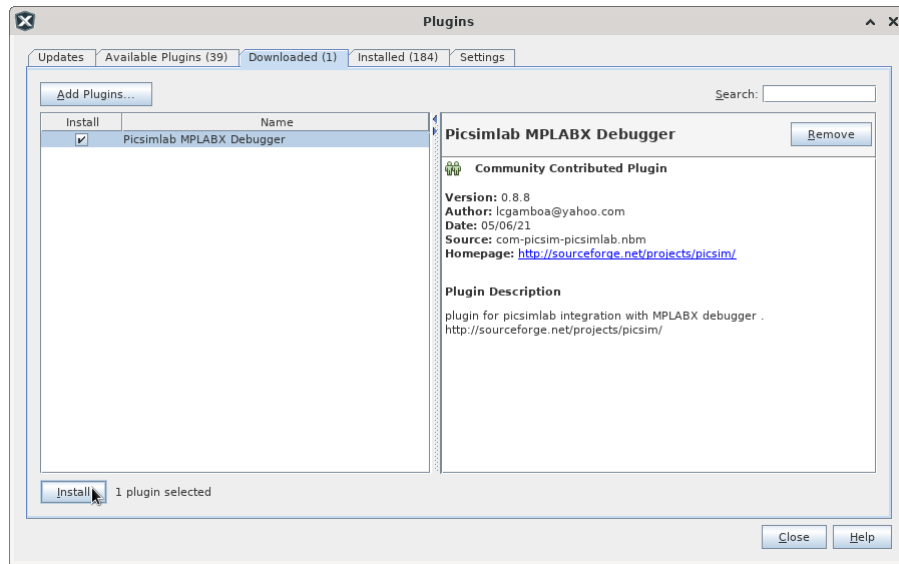

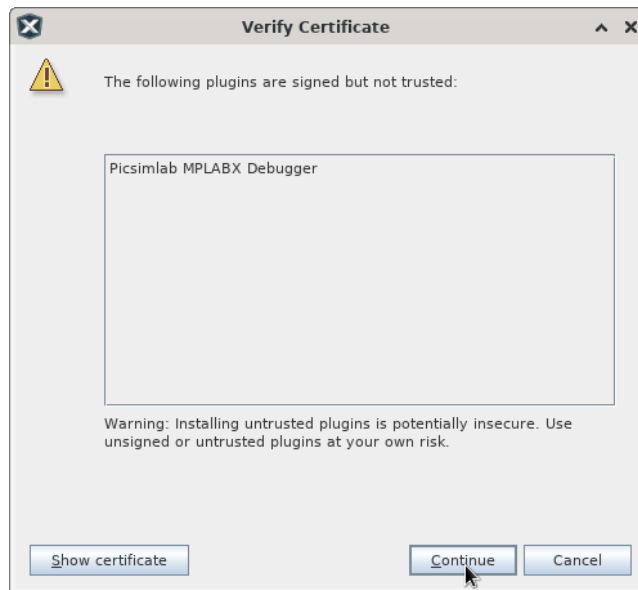
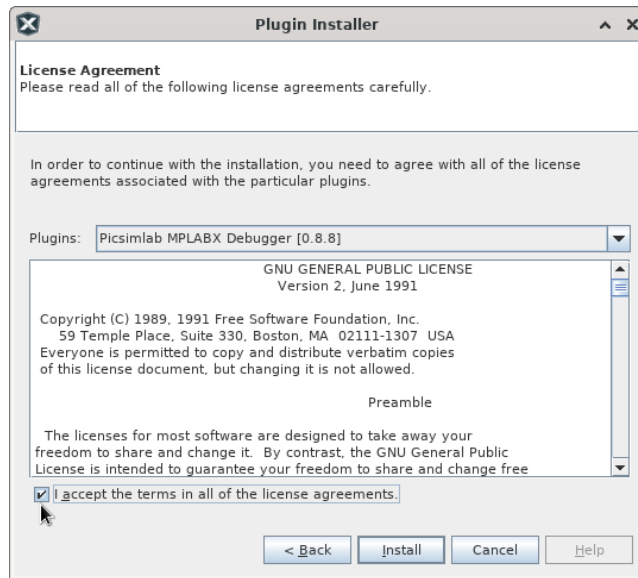

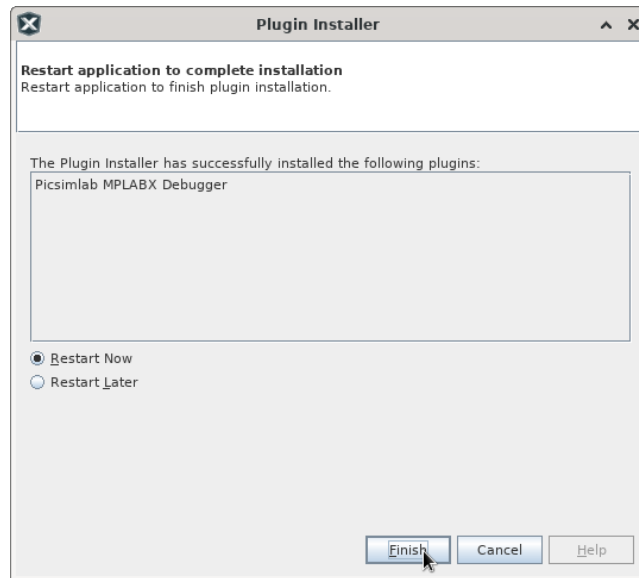

B.2 Configuring a New Project in MPLABX

B.2.1 Project Creation

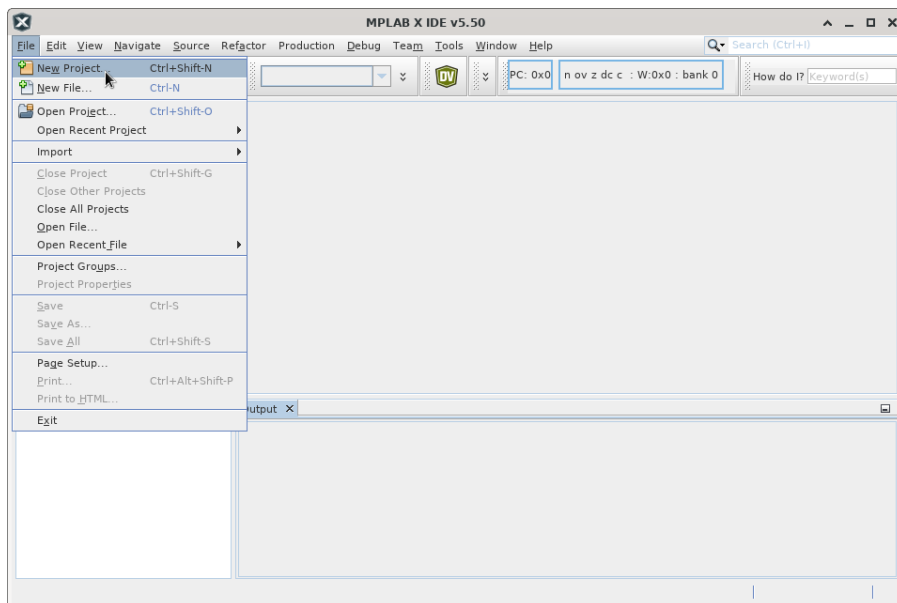

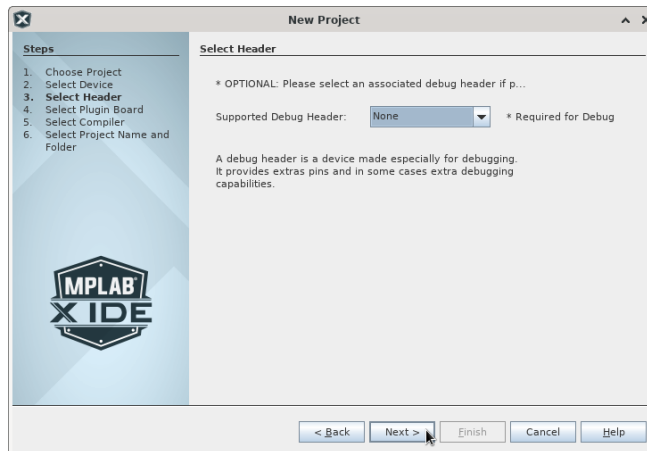
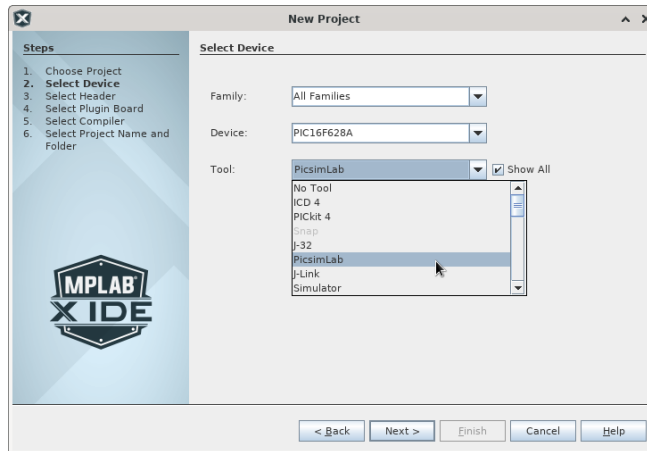
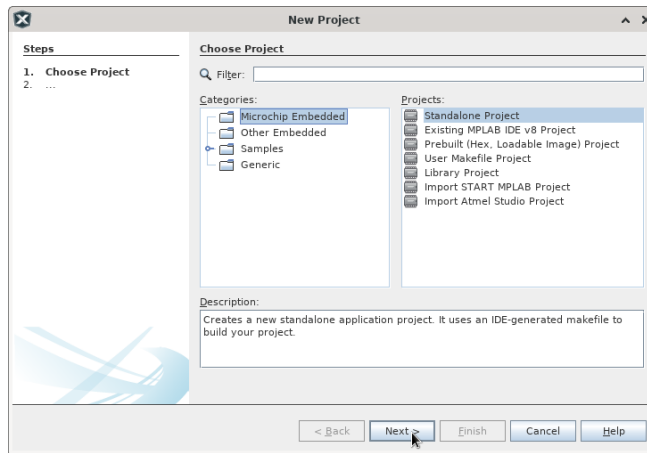

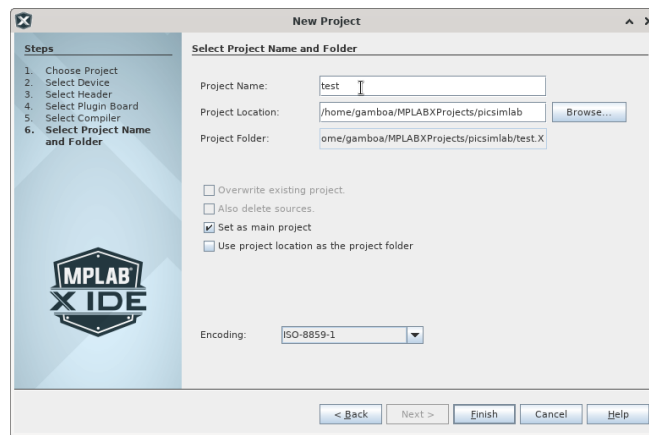
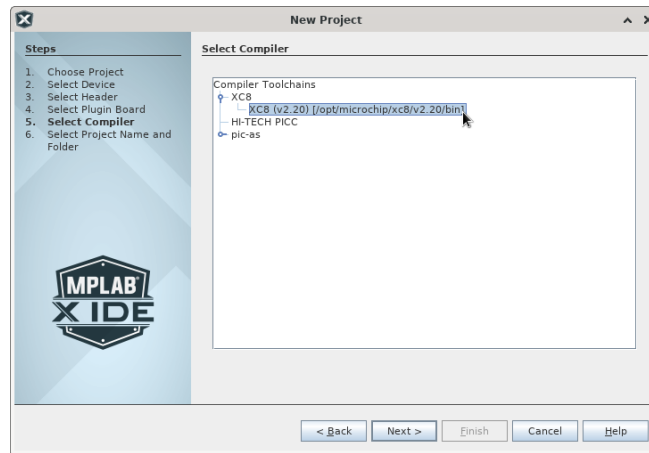

B.2.2 File Creation

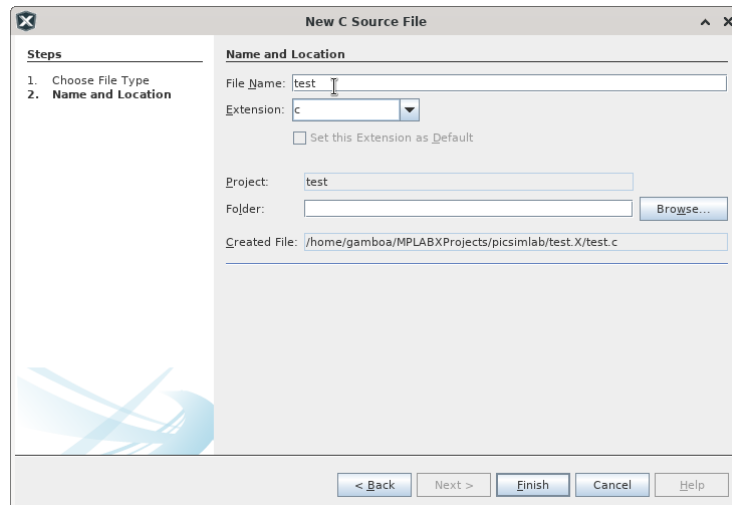
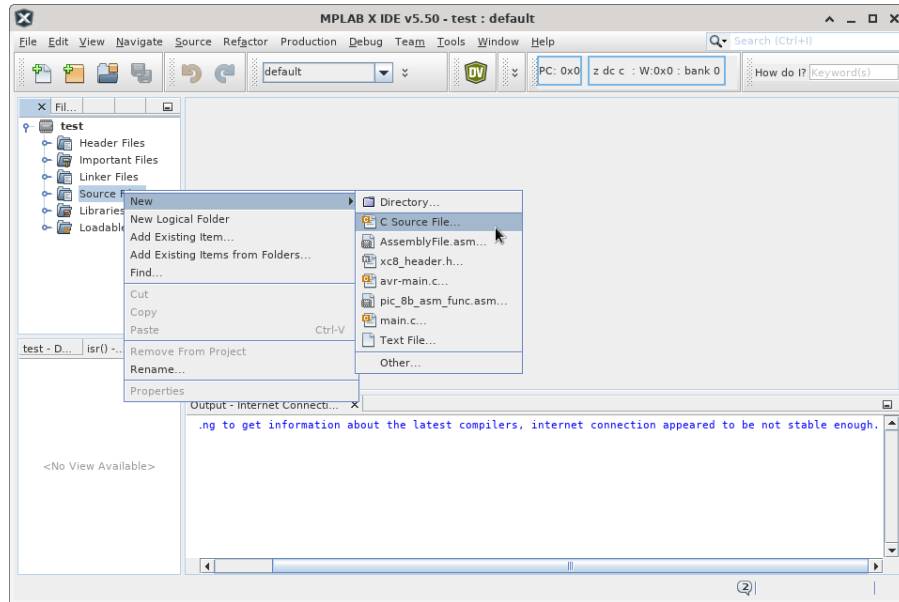

B.2.3 PIC Configuration Bits

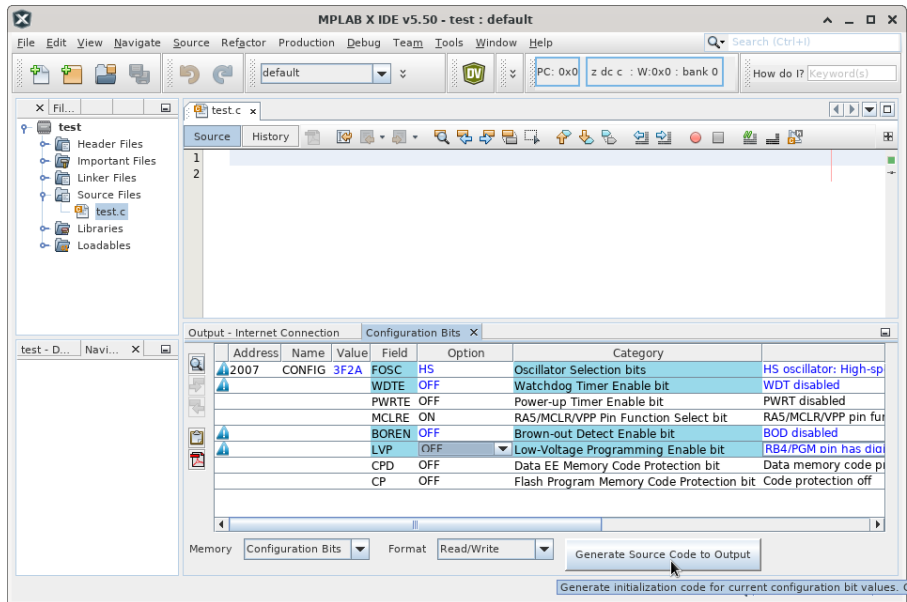
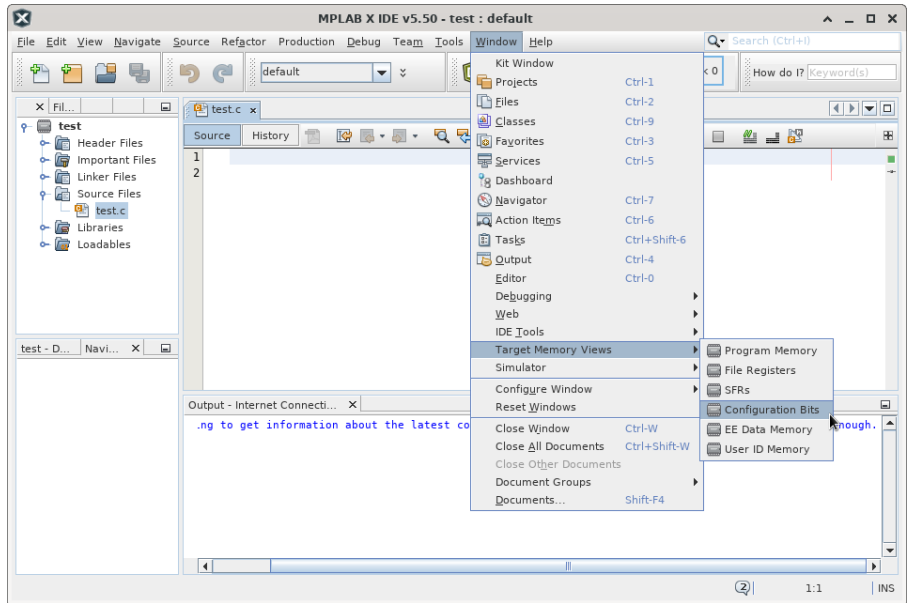

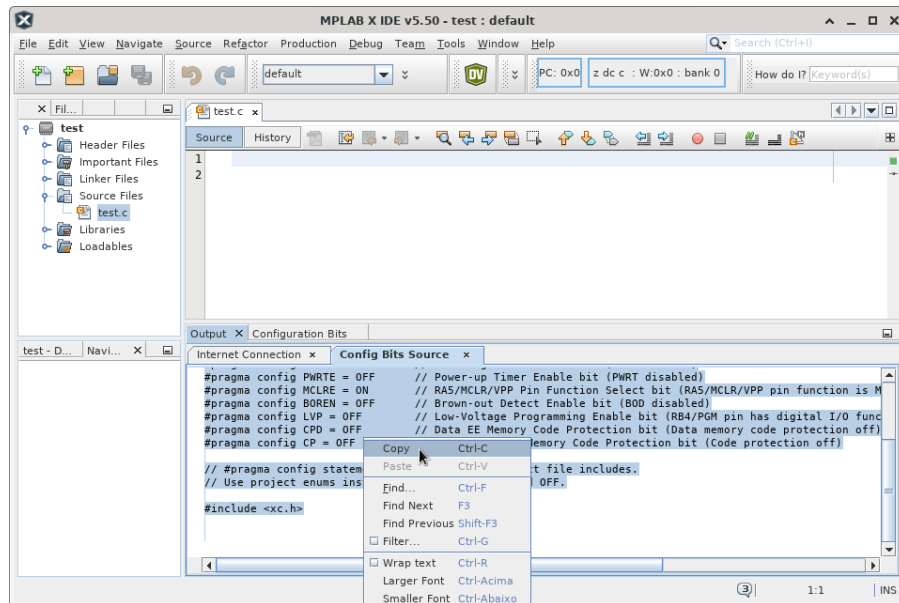

B.2.4 Code Example

Paste the configuration and this simple code example in test.c:

```
void main()
{
    TRISB=0x00; //All pins as output
    PORTB=0;    //All pins off
    while(1)   //main loop
    {
        PORTBbits.RB0=1; //Turn RB0 on
        PORTBbits.RB1=1; //Turn RB1 on
        PORTB=0; //All pins off
    }
}
```

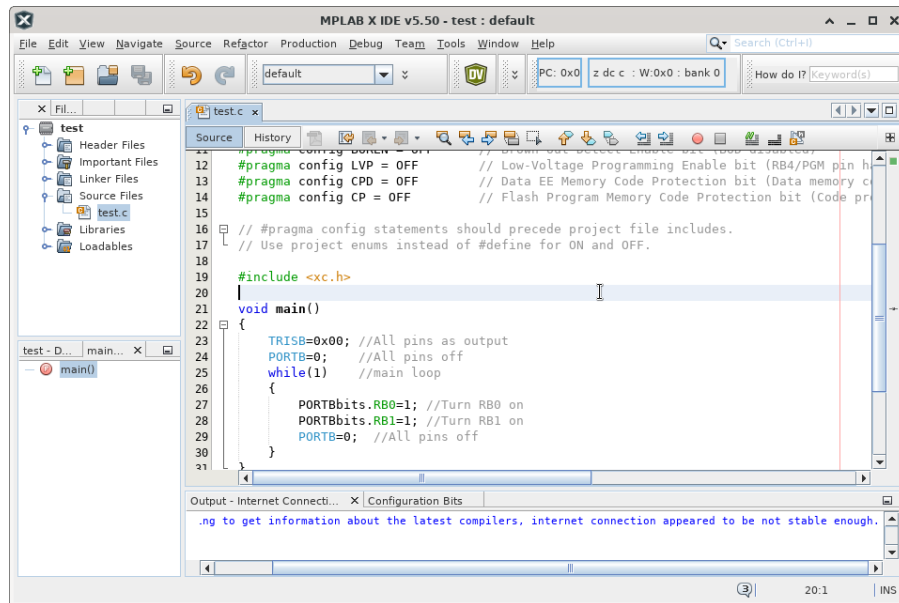

B.2.5 Building the Project

Use the **Build** button and wait for the message “**BUILD SUCCESSFUL**”.

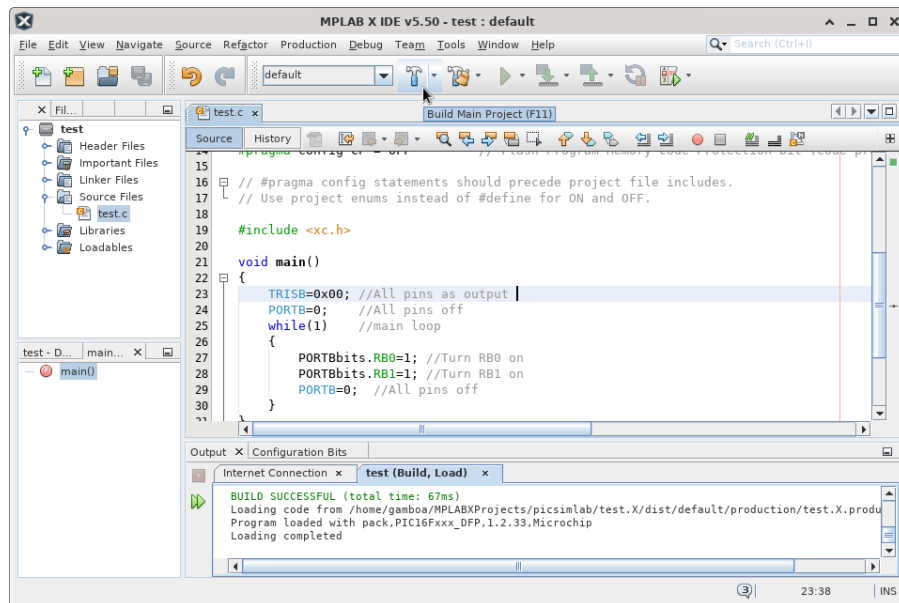

B.3 Program and Debug PICsimLab With MPLABX

B.3.1 Starting PICsimLab

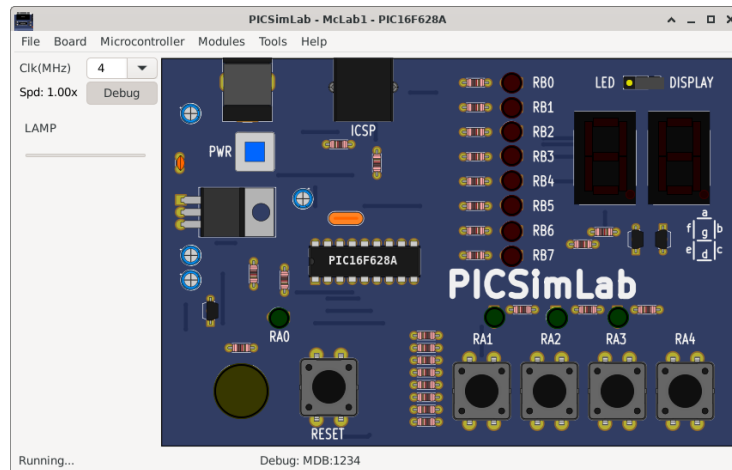

The plugin connect to Picsimlab through a TCP socket using port 1234, and you have to allow the access in the firewall. Verify in the PICsimLab statusbar the message "MplabxD: Ok". It's show debugger server state.

B.3.2 Programming PICsimLab

Use the **Debug** button to programming PICsimLab.

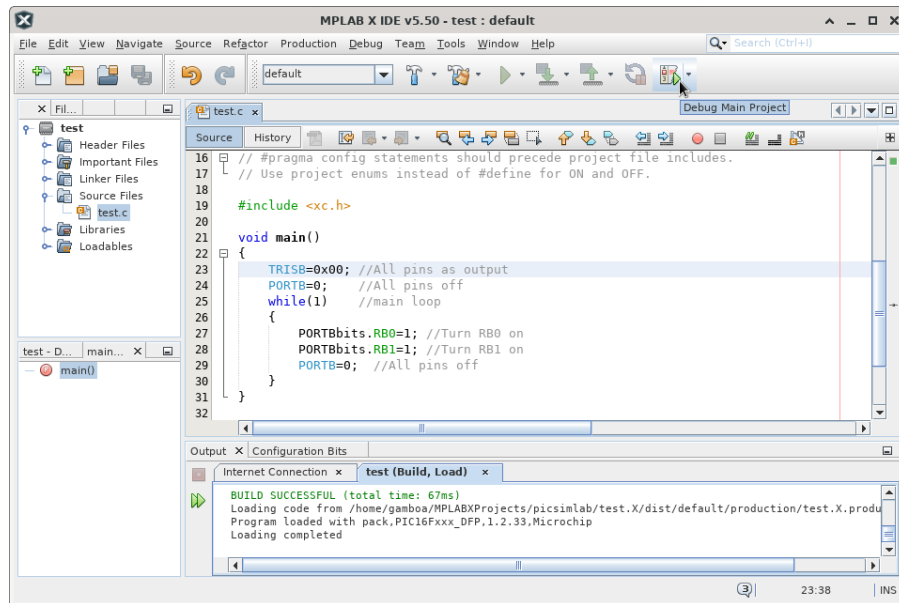

B.3.3 Pausing the Program

Use the **Pause** button to stop the program and inspect the code and memory.

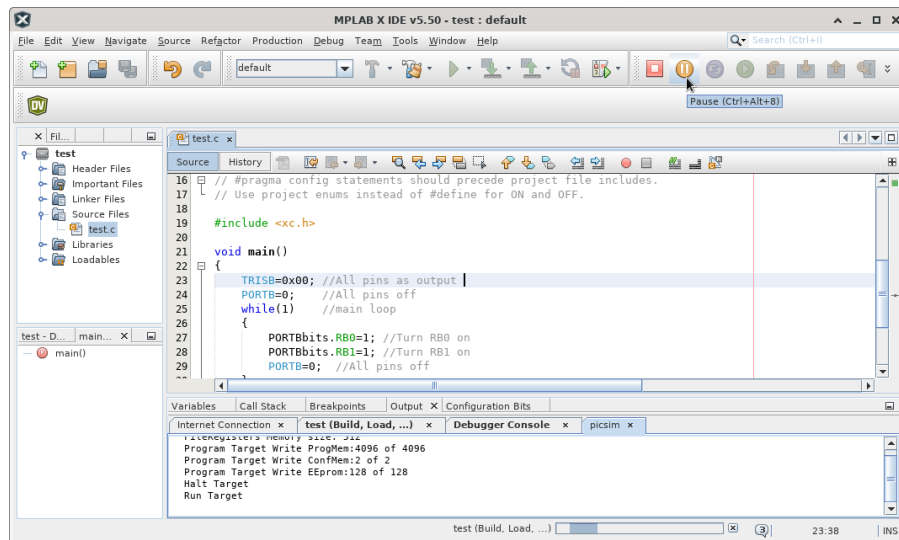

B.3.4 Restarting the Program

Use the **Restart** button to restart the program.

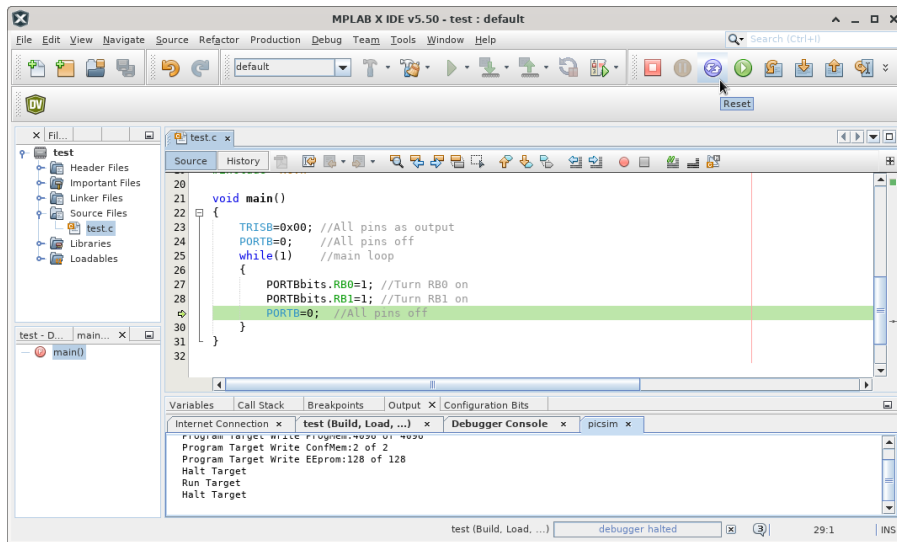

B.3.5 Running Step by Step

Use the **Step** or **Step Over** button to run the program step by step.

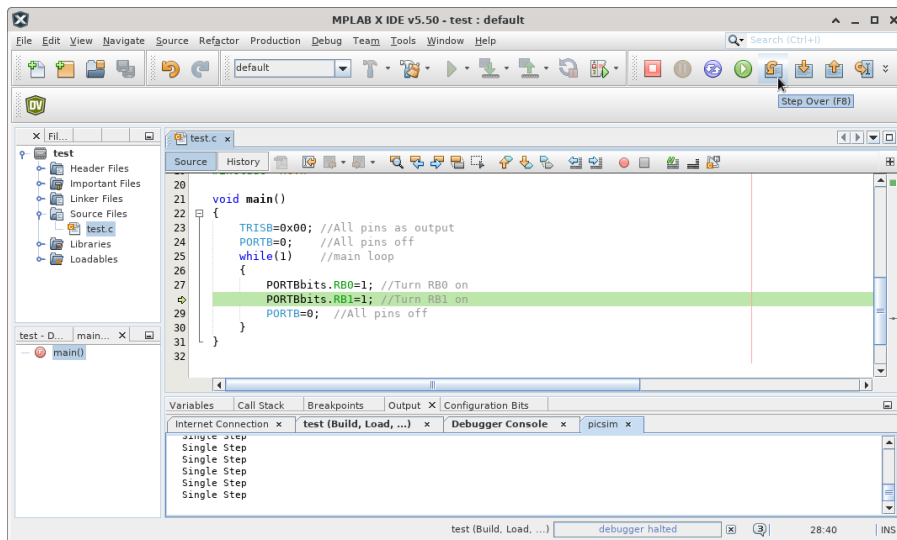

See in the PICsimLab the changes of each step.

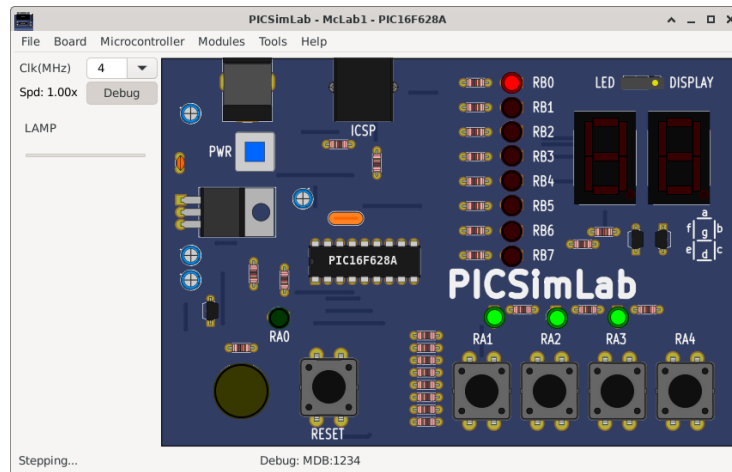

B.3.6 Stopping Debugger

Use the **Stop** button to turn off the MPLABX debugger.

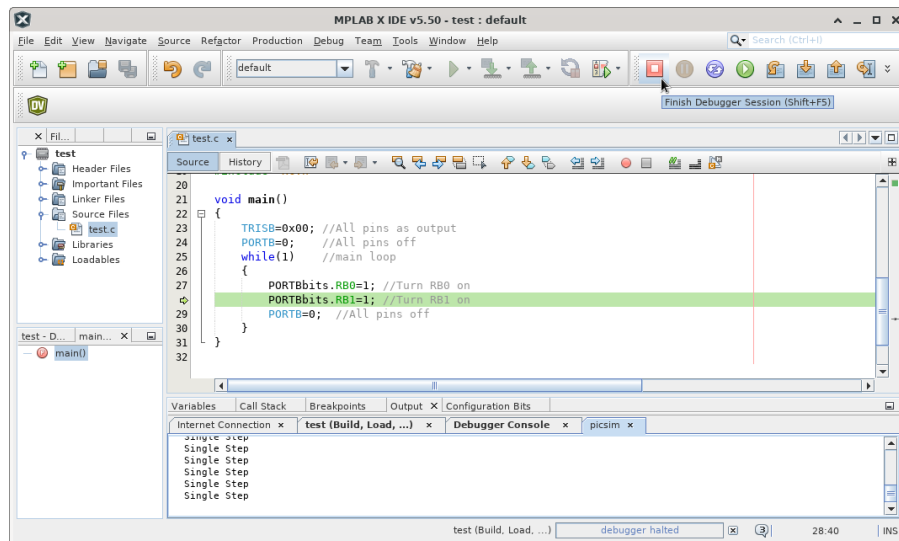

B.3.7 Disconnect Debugger

Use the menu **Debug->Disconnect From Debug Tool** to disconnect the MPLABX debugger. The program continues running in PICsimLab after MPLABX debugger is disconnected.

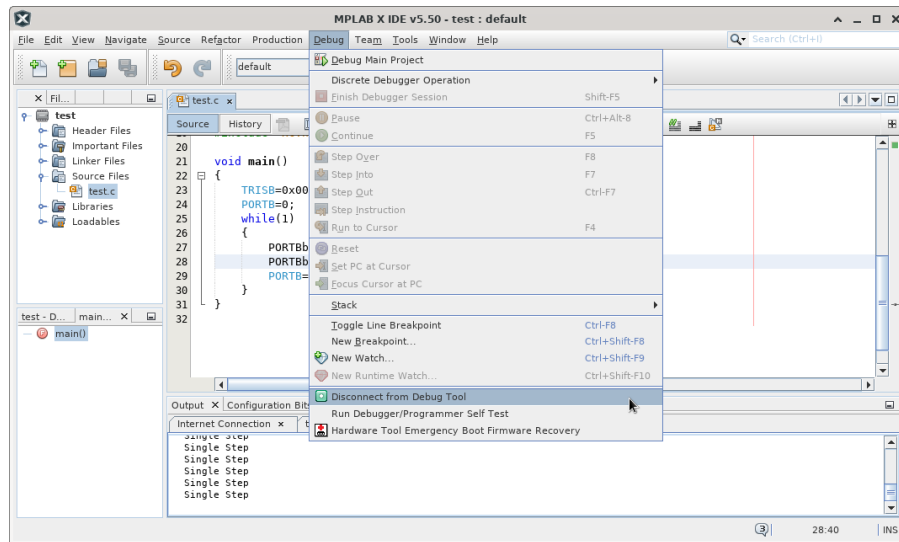

B.4 This Tutorial in Video

Link for Youtube video version of this tutorial: [How to use MPLABX to program and debug PcsimLab 0.6](#)

Appendix C

Creating New Boards

First get the source code and compile as described in [Install from source](#).

C.1 Creating a New Board

The first step is get the schematic and all information about the board hardware. The second step is the creation of four files in PICSimLab dir (consider replace the 'x' of board_x for a name of your board in your case):

- Board Picture (share/boards/X/board.svg) or (share/boards/X/board.png);
- Board map (share/boards/X/board.map);
- Board header (src/boards/board_x.h);
- Board C++ code (src/boards/board_x.cc);

The third and last step is recompiling PICSimLab with new board support.

C.1.1 Board Hardware and Schematic

For this tutorial, the board created have the hardware shown in diagram below:

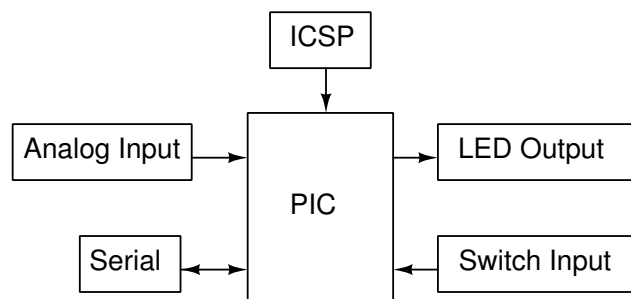

C.1.2 Board Picture

The PNG board picture was taken from [Kicad](#) 3D viewer. The picture image is saved as “share/board/X/board.png”.

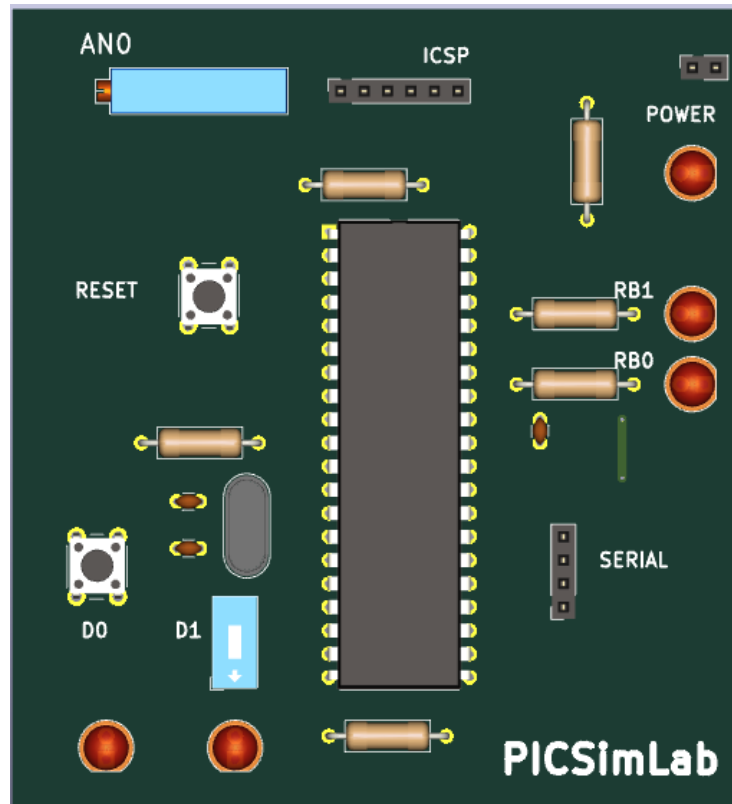

It is also possible to use images in SVG format for better viewing quality. [PCBDraw](#) can be used to convert a Kicad PCB project to an SVG image using the [PICSimLab PcbDraw Library](#). The picture image is saved as “share/board/X/board.svg”.

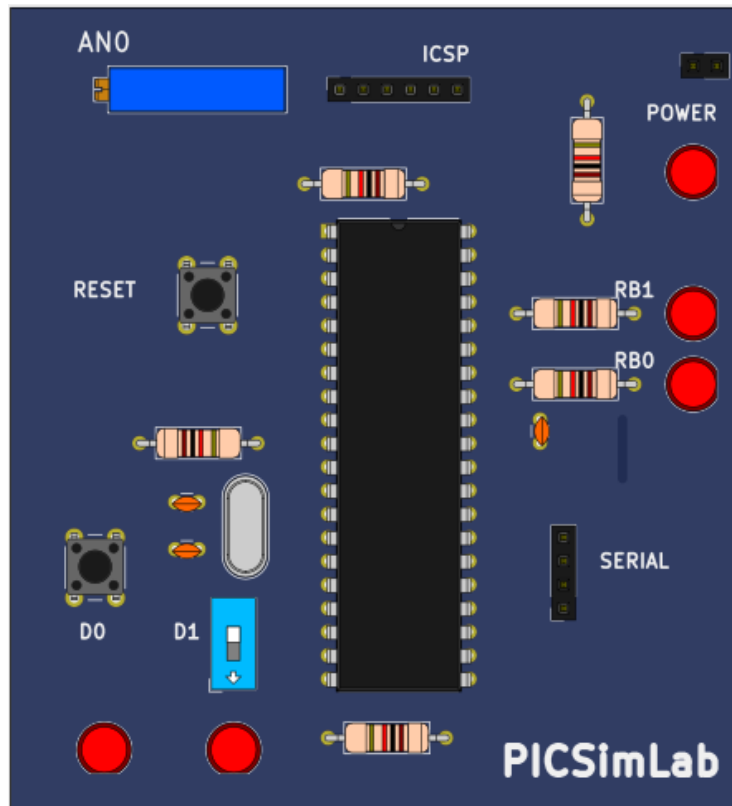

C.1.3 Picture map

The PICSimLab use one picture image map for inputs and outputs.

The inputs are the areas in board picture which user can interact (by mouse click) and start with letters “I_”.

The output are the areas in board picture to be redraw according simulator status and start with letters “O_”.

The bidirectional areas in board picture which user can interact and need to be redraw according simulator status are started with letter “B_”.

The picture map used for PICSimLab are normal HTML image-map. They can be made by hand or using any software which can handle image maps. The original PICSimLab maps are made using [Gimp image editor](#).

To start, in the GIMP, use the Filters->Web->Image Map to open image map editor window.

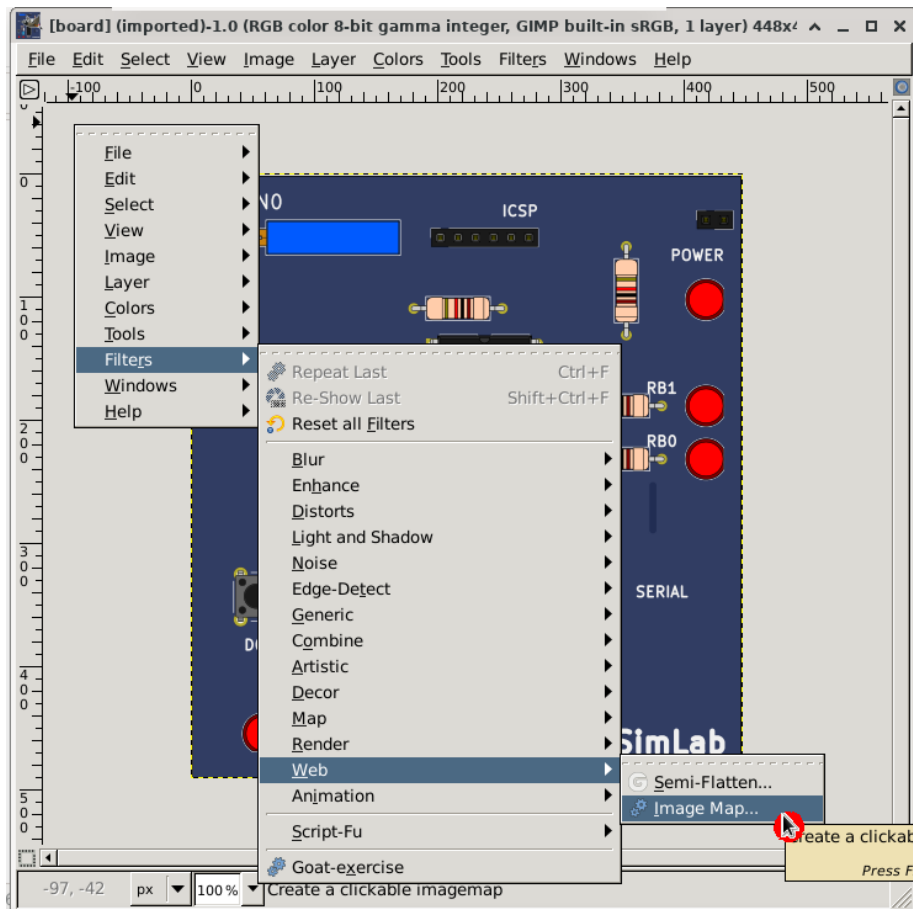

Then select rectangle or circle map on toolbar.

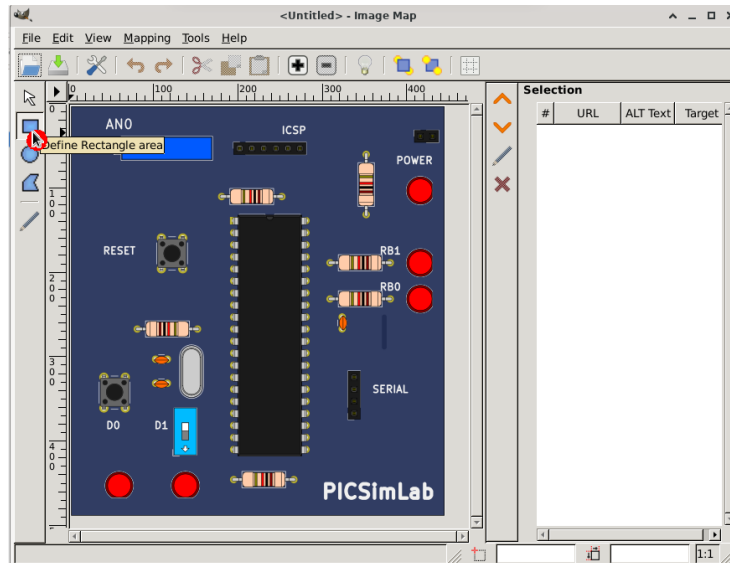

And mark the area in picture.

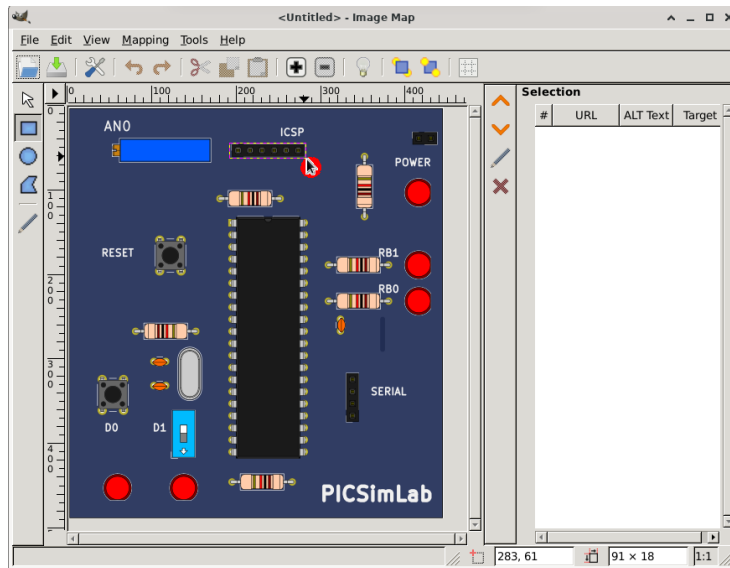

After area is select, in the settings windows select the link type for “Other”.

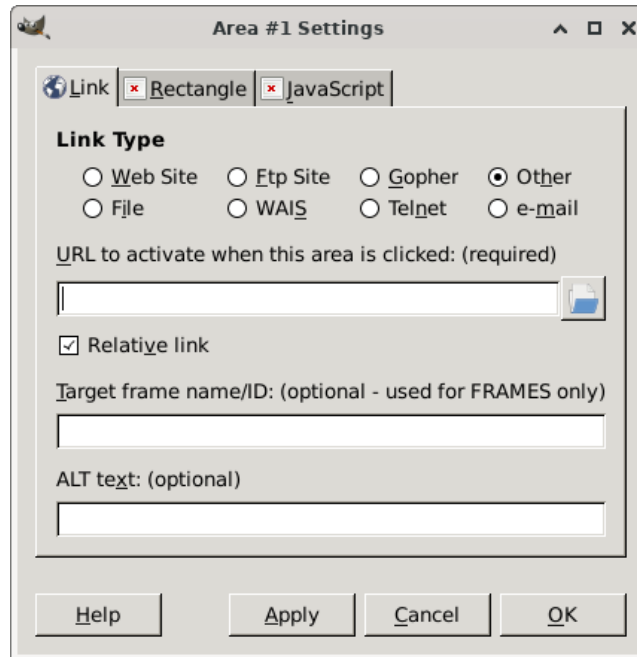

And write the name of area. The name must describe the area function on the board and follow the [Picture Map Reference](#).

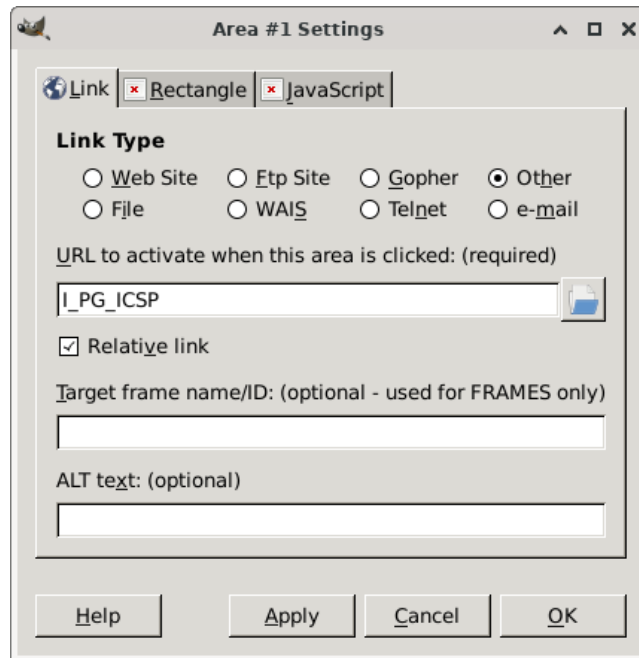

Board map

For this tutorial board, twelve areas are marked:

- I_PG_ICSP - where user click to load hexfile.
- I_SW_PWR - where user click to turn on/off the board.
- B_SW_D1 - Switch connected in RD1.
- B_PO_1 - Potentiometer connected to RA0.
- B_PB_RST - Button to reset board.
- B_PB_D0 - Button connected in RD0.
- O_LD_LD0 - draw LED connected in push button D0.
- O_LD_LD1 - draw LED connected in switch D1.
- O_LD_LPWR - draw power LED indicator.
- O_LD_RB1 - draw LED connected in RB1.
- O_LD_RB0 - draw LED connected in RB0.
- O_IC_CPU - draw microcontroller name.

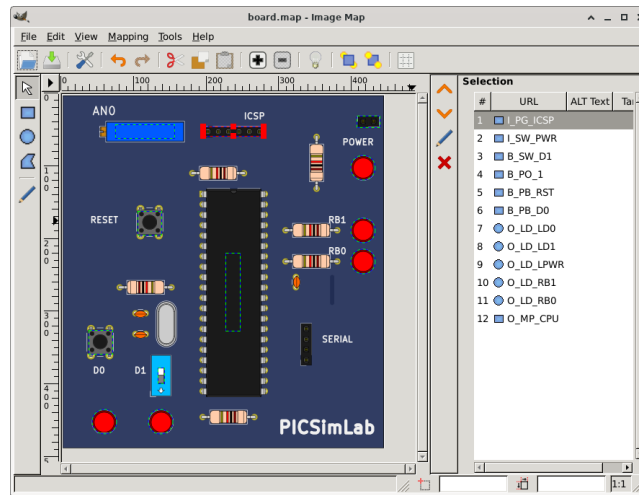

Board map generated by Gimp image map editor and saved as “share/boards/X/board.map”.

```

1 
2
3 <map name="map">
4 <!-- # $ -:Image map file created by GIMP Image Map plug-in -->
5 <!-- # $ -:GIMP Image Map plug-in by Maurits Rijk -->
6 <!-- # $ -:Please do not edit lines starting with "#$" -->
7 <!-- # $ VERSION:2.3 -->
8 <!-- # $ AUTHOR:lcgamboa@yahoo.com -->
9 <area shape="rect" coords="196,45,280,58" href="I_PG_ICSP" />
10 <area shape="rect" coords="409,30,441,46" href="I_SW_PWR" />
11 <area shape="rect" coords="133,379,142,401" href="B_SW_D1" />
12 <area shape="rect" coords="74,42,156,61" href="B_PO_1" />
13 <area shape="rect" coords="105,162,138,195" href="B_PB_RST" />
14 <area shape="rect" coords="37,327,70,360" href="B_PB_D0" />
15 <area shape="circle" coords="59,454,17" href="O_LD_LD0" />
16 <area shape="circle" coords="137,454,17" href="O_LD_LD1" />
17 <area shape="circle" coords="418,102,17" href="O_LD_LPWR" />
18 <area shape="circle" coords="418,189,17" href="O_LD_RB1" />
19 <area shape="circle" coords="418,232,17" href="O_LD_RB0" />
20 <area shape="rect" coords="227,220,247,328" href="O_IC_CPU" />
21 </map>

```

The kicad project files can be download from github [PICSimLab repository](#).

C.1.4 Board code

The header file and c++ code file with comments are listed in the next two subsections. This files control the behavior of board in simulator.

board_x.h[board_x.h online file.](#)[board_x.h online doxygen version.](#)

```

1  /* #####
2
3  PICsimLab - PIC laboratory simulator
4
5  #####
6
7  Copyright (c) : 2015-2021 Luis Claudio Gambôa Lopes
8
9  This program is free software; you can redistribute it and/or modify
10 it under the terms of the GNU General Public License as published by
11 the Free Software Foundation; either version 2, or (at your option)
12 any later version.
13
14 This program is distributed in the hope that it will be useful,
15 but WITHOUT ANY WARRANTY; without even the implied warranty of
16 MERCHANTABILITY or FITNESS FOR A PARTICULAR PURPOSE. See the
17 GNU General Public License for more details.
18
19 You should have received a copy of the GNU General Public License
20 along with this program; if not, write to the Free Software
21 Foundation, Inc., 675 Mass Ave, Cambridge, MA 02139, USA.
22
23 For e-mail suggestions : lcgamboa@yahoo.com
24 ##### */
25
26 #ifndef BOARD_x_H
27 #define BOARD_x_H
28
29 #include<lxrad.h>
30
31 #include "bsim_picsim.h"
32
33 #define BOARD_x_Name "X"
34
35 //new board class must be derived from board class defined in board.h
36 class cboard_x:public bsim_picsim
37 {
38     private:
39         unsigned char p_BT1; //first board push button in RD0
40         unsigned char p_BT2; //second board switch in RD1
41
42         //value of potentiometer
43         unsigned char pot1;

```

```

44     //flag to control if potentiometer is active
45     unsigned char active;
46
47     //controls to be added in simulator window
48     CGauge *gauge1;    //gauge to show mean value of RB0
49     CGauge *gauge2;    //gauge to show mean value of RB1
50     CLabel *label2;    //label of gauge RB0
51     CLabel *label3;    //label of gauge RB1
52
53     //Register controls for remote interface called once on board creation
54     void RegisterRemoteControl(void);
55
56     lxColor color1; //LEDs color 1
57     lxColor color2; //LEDs color 2
58     lxFont font;
59 public:
60     //Constructor called once on board creation
61     cboard_x(void);
62     //Destructor called once on board destruction
63     ~cboard_x(void);
64     //Return the board name
65     lxString GetName(void) {return lxT(BOARD_x_Name); };
66     //Return the about info of board
67     lxString GetAboutInfo(void){return lxT("L.C. Gamboa \n <lcgamboa@yahoo.com>");};
68     //Called ever 100ms to draw board
69     void Draw(CDraw *draw);
70     void Run_CPU(void);
71     //Return a list of board supported microcontrollers
72     lxString GetSupportedDevices(void) {return lxT("PIC16F877A,PIC18F4550,PIC18F4620,");};
73     //Reset board status
74     void Reset(void);
75     //Event on the board
76     void EvMouseButtonPress(uint button, uint x, uint y,uint state);
77     //Event on the board
78     void EvMouseButtonRelease(uint button, uint x, uint y,uint state);
79     //Event on the board
80     void EvMouseMove(uint button, uint x, uint y, uint state);
81     //Event on the board
82     void EvKeyPress(uint key,uint mask);
83     //Event on the board
84     void EvKeyRelease(uint key,uint mask);
85     //Called ever 1s to refresh status
86     void RefreshStatus(void);
87     //Called to save board preferences in configuration file
88     void WritePreferences(void);
89     //Called whe configuration file load preferences
90     void ReadPreferences(char *name, char *value);

```

```
91     //return the input ids numbers of names used in input map
92     unsigned short get_in_id(char * name);
93     //return the output ids numbers of names used in output map
94     unsigned short get_out_id(char * name);
95 };
96
97 #endif      /* BOARD_x_H */
98
```

board_x.cc[board_x.cc online file.](#)[board_x.cc online doxygen version.](#)

```

1  /* #####
2
3  PICsimLab - PIC laboratory simulator
4
5  #####
6
7  Copyright (c) : 2015-2021 Luis Claudio Gambôa Lopes
8
9  This program is free software; you can redistribute it and/or modify
10 it under the terms of the GNU General Public License as published by
11 the Free Software Foundation; either version 2, or (at your option)
12 any later version.
13
14 This program is distributed in the hope that it will be useful,
15 but WITHOUT ANY WARRANTY; without even the implied warranty of
16 MERCHANTABILITY or FITNESS FOR A PARTICULAR PURPOSE. See the
17 GNU General Public License for more details.
18
19 You should have received a copy of the GNU General Public License
20 along with this program; if not, write to the Free Software
21 Foundation, Inc., 675 Mass Ave, Cambridge, MA 02139, USA.
22
23 For e-mail suggestions : lcgamboa@yahoo.com
24 ##### */
25
26 //include files
27 #include "../picsimlab1.h"
28 #include "../picsimlab4.h" //Oscilloscope
29 #include "../picsimlab5.h" //Spare Parts
30 #include "board_x.h"
31
32 /* ids of inputs of input map*/
33 enum
34 {
35     I_POT1, //potentiometer
36     I_ICSP, //ICSP connector
37     I_PWR, //Power button
38     I_RST, //Reset button
39     I_BD0, //RD0 push button
40     I_SD1 //RD1 switch
41 };
42
43 /* ids of outputs of output map*/

```

```

44 enum
45 {
46     O_POT1, //potentiometer
47     O_RST, //Reset button
48     O_SD1, //switch position (On/Off)
49     O_LD0, //LED on RD0 push button
50     O_LD1, //LED on RD1 switch
51     O_LPWR, //Power LED
52     O_RB0, //LED on RB0 output
53     O_RB1, //LED on RB1 output
54     O_BD0, //RD1 switch
55     O_CPU //CPU name
56 };
57
58 //return the input ids numbers of names used in input map
59
60 unsigned short
61 cboard_x::get_in_id(char * name)
62 {
63     if (strcmp (name, "PG_ICSP") == 0) return I_ICSP;
64     if (strcmp (name, "SW_PWR") == 0) return I_PWR;
65     if (strcmp (name, "PB_RST") == 0) return I_RST;
66     if (strcmp (name, "PB_D0") == 0) return I_BD0;
67     if (strcmp (name, "SW_D1") == 0) return I_SD1;
68     if (strcmp (name, "PO_1") == 0) return I_POT1;
69
70     printf ("Error input '%s' don't have a valid id! \n", name);
71     return -1;
72 }
73
74 //return the output ids numbers of names used in output map
75
76 unsigned short
77 cboard_x::get_out_id(char * name)
78 {
79
80     if (strcmp (name, "SW_D1") == 0) return O_SD1;
81     if (strcmp (name, "LD_LD0") == 0) return O_LD0;
82     if (strcmp (name, "LD_LD1") == 0) return O_LD1;
83     if (strcmp (name, "LD_LPWR") == 0) return O_LPWR;
84     if (strcmp (name, "LD_RB1") == 0) return O_RB1;
85     if (strcmp (name, "LD_RB0") == 0) return O_RB0;
86     if (strcmp (name, "PB_D0") == 0) return O_BD0;
87     if (strcmp (name, "PO_1") == 0) return O_POT1;
88     if (strcmp (name, "PB_RST") == 0) return O_RST;
89     if (strcmp (name, "IC_CPU") == 0) return O_CPU;
90
91     printf ("Error output '%s' don't have a valid id! \n", name);

```

```
92     return 1;
93 }
94
95 //Constructor called once on board creation
96
97 cboard_x::cboard_x(void) :
98 font(10, 1xFONTFAMILY_TELETYPE, 1xFONTSTYLE_NORMAL, 1xFONTWEIGHT_BOLD)
99 {
100     Proc = "PIC18F4550"; //default microcontroller if none defined in preferences
101     ReadMaps (); //Read input and output board maps
102
103     pot1 = 100;
104
105     active = 0;
106
107     //controls properties and creation
108     //gauge1
109     gauge1 = new CGauge ();
110     gauge1->SetFOwner (&Window1);
111     gauge1->SetName (1xT ("gauge1_px"));
112     gauge1->SetX (13);
113     gauge1->SetY (382 - 160);
114     gauge1->SetWidth (140);
115     gauge1->SetHeight (20);
116     gauge1->SetEnable (1);
117     gauge1->SetVisible (1);
118     gauge1->SetRange (100);
119     gauge1->SetValue (0);
120     gauge1->SetType (4);
121     Window1.CreateChild (gauge1);
122     //gauge2
123     gauge2 = new CGauge ();
124     gauge2->SetFOwner (&Window1);
125     gauge2->SetName (1xT ("gauge2_px"));
126     gauge2->SetX (12);
127     gauge2->SetY (330 - 160);
128     gauge2->SetWidth (140);
129     gauge2->SetHeight (20);
130     gauge2->SetEnable (1);
131     gauge2->SetVisible (1);
132     gauge2->SetRange (100);
133     gauge2->SetValue (0);
134     gauge2->SetType (4);
135     Window1.CreateChild (gauge2);
136     //label2
137     label2 = new CLabel ();
138     label2->SetFOwner (&Window1);
```

```
139 label2->SetName (lxT ("label2_px"));
140 label2->SetX (12);
141 label2->SetY (306 - 160);
142 label2->SetWidth (60);
143 label2->SetHeight (20);
144 label2->SetEnable (1);
145 label2->SetVisible (1);
146 label2->SetText (lxT ("RB0"));
147 label2->SetAlign (1);
148 Window1.CreateChild (label2);
149 //label3
150 label3 = new CLabel ();
151 label3->SetFOwner (&Window1);
152 label3->SetName (lxT ("label3_px"));
153 label3->SetX (13);
154 label3->SetY (357 - 160);
155 label3->SetWidth (60);
156 label3->SetHeight (20);
157 label3->SetEnable (1);
158 label3->SetVisible (1);
159 label3->SetText (lxT ("RB1"));
160 label3->SetAlign (1);
161 Window1.CreateChild (label3);
162 }
163
164 //Destructor called once on board destruction
165
166 cboard_x::~cboard_x(void)
167 {
168     //controls destruction
169     Window1.DestroyChild (gauge1);
170     Window1.DestroyChild (gauge2);
171     Window1.DestroyChild (label2);
172     Window1.DestroyChild (label3);
173 }
174
175 //Reset board status
176
177 void
178 cboard_x::Reset(void)
179 {
180     pic_reset (1);
181
182     p_BT1 = 1; //set push button in default state (high)
183
184     //write button state to pic pin 19 (RD0)
185     pic_set_pin (19, p_BT1);
```



```

186 //write switch state to pic pin 20 (RD1)
187 pic_set_pin (20, p_BT2);
188
189
190 //verify serial port state and refresh status bar
191 #ifndef _WIN_
192 if (pic.serial[0].serialfd > 0)
193 #else
194 if (pic.serial[0].serialfd != INVALID_HANDLE_VALUE)
195 #endif
196     Window1.statusbar1.SetField (2, lxT ("Serial: ") +
197                                 lxString::FromAscii (SERIALDEVICE) + lxT (":") + itoa (pic.serial[0].
198                                 lxString ().Format ("%4.1f", fabs ((100.0 * pic.serial[0].serialbaud) / pic.
199                                 pic.serial[0].serialbaud) / pic.
200 else
201     Window1.statusbar1.SetField (2, lxT ("Serial: ") +
202                                 lxString::FromAscii (SERIALDEVICE) + lxT (" (ERROR)"));
203
204 if (use_spare)Window5.Reset ();
205
206 RegisterRemoteControl ();
207 }
208
209 //Register variables to be controled by remote control
210
211 void
212 cboard_x::RegisterRemoteControl (void)
213 {
214     //register inputa
215     input_ids[I_BD0]->status = &p_BT1;
216     input_ids[I_SD1]->status = &p_BT2;
217     input_ids[I_POT1]->status = &pot1;
218
219     //register output to be updated on input change
220     input_ids[I_BD0]->update = &output_ids[O_BD0]->update;
221     input_ids[I_SD1]->update = &output_ids[O_SD1]->update;
222     input_ids[I_POT1]->update = &output_ids[O_POT1]->update;
223
224     //register outputa
225     output_ids[O_RB0]->status = &pic.pins[32].oavalue;
226     output_ids[O_RB1]->status = &pic.pins[33].oavalue;
227     output_ids[O_LD0]->status = &pic.pins[18].oavalue;
228     output_ids[O_LD1]->status = &pic.pins[19].oavalue;
229 }
230
231 //Called ever 1s to refresh status
232

```

```

233 void
234 cboard_x::RefreshStatus(void)
235 {
236     //verify serial port state and refresh status bar
237     #ifndef _WIN_
238         if (pic.serial[0].serialfd > 0)
239         #else
240         if (pic.serial[0].serialfd != INVALID_HANDLE_VALUE)
241         #endif
242             Window1.statusbar1.SetField (2, lxT ("Serial: ") +
243                 lxString::FromAscii (SERIALDEVICE) + lxT (":") + itoa (pic.serial[0].
244                 lxString ().Format ("%4.1f", fabs ((100.0 * pic.serial[0].serialbaud) / pic.
245                 pic.serial[0].serialbaud) / pic.
246             else
247             Window1.statusbar1.SetField (2, lxT ("Serial: ") +
248                 lxString::FromAscii (SERIALDEVICE) + lxT (" (ERROR)"));
249         }
250     }
251
252     //Called to save board preferences in configuration file
253
254 void
255 cboard_x::WritePreferences(void)
256 {
257     //write selected microcontroller of board_x to preferences
258     Window1.saveprefs (lxT ("X_proc"), Proc);
259     //write switch state of board_x to preferences
260     Window1.saveprefs (lxT ("X_bt2"), lxString ().Format ("%i", p_BT2));
261     //write microcontroller clock to preferences
262     Window1.saveprefs (lxT ("X_clock"), lxString ().Format ("%2.1f", Window1.GetClock ()));
263     //write potentiometer position to preferences
264     Window1.saveprefs (lxT ("X_pot1"), lxString ().Format ("%i", pot1));
265 }
266
267 //Called whe configuration file load preferences
268
269 void
270 cboard_x::ReadPreferences(char *name, char *value)
271 {
272     //read switch state of board_x of preferences
273     if (!strcmp (name, "X_bt2"))
274     {
275         if (value[0] == '0')
276             p_BT2 = 0;
277         else
278             p_BT2 = 1;
279     }

```

```
280 //read microcontroller of preferences
281 if (!strcmp (name, "X_proc"))
282 {
283     Proc = value;
284 }
285 //read microcontroller clock
286 if (!strcmp (name, "X_clock"))
287 {
288     Window1.SetClock (atof (value));
289 }
290
291 //read potentiometer position
292 if (!strcmp (name, "X_pot1"))
293 {
294     pot1 = atoi (value);
295 }
296 }
297
298
299 //Event on the board
300
301 void
302 cboard_x::EvKeyPress(uint key, uint mask)
303 {
304     //if keyboard key 1 is pressed then activate button (state=0)
305     if (key == '1')
306     {
307         p_BT1 = 0;
308         output_ids[O_BD0]->update = 1;
309     }
310
311     //if keyboard key 2 is pressed then toggle switch state
312     if (key == '2')
313     {
314         p_BT2 ^= 1;
315         output_ids[O_SD1]->update = 1;
316     }
317 }
318 }
319
320 //Event on the board
321
322 void
323 cboard_x::EvKeyRelease(uint key, uint mask)
324 {
325     //if keyboard key 1 is pressed then deactivate button (state=1)
326     if (key == '1')
```

```

327     {
328         p_BT1 = 1;
329         output_ids[O_BD0]->update = 1;
330     }
331
332 }
333
334 //Event on the board
335
336 void
337 cboard_x::EvMouseButtonPress(uint button, uint x, uint y, uint state)
338 {
339
340     int i;
341
342     //search for the input area which owner the event
343     for (i = 0; i < inputc; i++)
344     {
345         if (((input[i].x1 <= x) && (input[i].x2 >= x)) && ((input[i].y1 <= y) &&
346                                                         (input[i].y2 >= y)))
347         {
348
349             switch (input[i].id)
350             {
351                 //if event is over I_ISCP area then load hex file
352                 case I_ICSP:
353                     Window1.menu1_File_LoadHex_EvMenuActive (NULL);
354                     break;
355                 //if event is over I_PWR area then toggle board on/off
356                 case I_PWR:
357                     if (Window1.Get_mcupwr ()) //if on turn off
358                     {
359                         Window1.Set_mcurun (0);
360                         Window1.Set_mcupwr (0);
361                         Reset ();
362                         p_BT1 = 1;
363                         Window1.statusbar1.SetField (0, lxT ("Stoped"));
364                     }
365                     else //if off turn on
366                     {
367                         Window1.Set_mcupwr (1);
368                         Window1.Set_mcurun (1);
369                         Reset ();
370                         Window1.statusbar1.SetField (0, lxT ("Running..."));
371                     }
372                     output_ids[O_LPWR]->update = 1;
373                     break;

```

```

374     //if event is over I_RST area then turn off and reset
375     case I_RST:
376         if (Window1.Get_mcupwr () && pic_reset (-1))//if powered
377             {
378                 Window1.Set_mcupwr (0);
379                 Window1.Set_mcurst (1);
380             }
381         p_RST = 0;
382         output_ids[O_RST]->update = 1;
383         break;
384     //if event is over I_D0 area then activate button (state=0)
385     case I_BD0:
386         p_BT1 = 0;
387         output_ids[O_BD0]->update = 1;
388         break;
389     //if event is over I_D1 area then toggle switch state
390     case I_SD1:
391         p_BT2 ^= 1;
392         output_ids[O_SD1]->update = 1;
393         break;
394     case I_POT1:
395         {
396             active = 1;
397             pot1 = (x - input[i].x1)*2.77;
398             if (pot1 > 199)pot1 = 199;
399             output_ids[O_POT1]->update = 1;
400         }
401         break;
402     }
403 }
404 }
405
406 }
407
408 //Event on the board
409
410 void
411 cboard_x::EvMouseMove(uint button, uint x, uint y, uint state)
412 {
413     int i;
414
415     for (i = 0; i < inputc; i++)
416     {
417         switch (input[i].id)
418         {
419             case I_POT1:
420                 if (((input[i].x1 <= x)&&(input[i].x2 >= x))&&((input[i].y1 <= y)&&(input[i].y2 >= y)))

```



```

468     break;
469     case I_POT1:
470     {
471         active = 0;
472         output_ids[O_POT1]->update = 1;
473     }
474     break;
475 }
476 }
477 }
478
479 }
480
481
482 //Called ever 100ms to draw board
483 //This is the critical code for simulator running speed
484
485 void
486 cboard_x::Draw(CDraw *draw)
487 {
488     int update = 0; //verify if updated is needed
489     int i;
490
491
492     //board_x draw
493     for (i = 0; i < outputc; i++) //run over all outputs
494     {
495         if (output[i].update) //only if need update
496         {
497             output[i].update = 0;
498
499             if (!update)
500             {
501                 draw->Canvas.Init (Scale, Scale);
502             }
503             update++; //set to update buffer
504
505             if (!output[i].r) //if output shape is a rectangle
506             {
507                 if (output[i].id == O_SD1) //if output is switch
508                 {
509                     //draw a background white rectangle
510                     draw->Canvas.SetBgColor (255, 255, 255);
511                     draw->Canvas.Rectangle (1, output[i].x1, output[i].y1,
512                                             output[i].x2 - output[i].x1, output[i].y2 - output[i].y1);
513
514                     if (!p_BT2) //draw switch off

```

```
515     {
516         //draw a grey rectangle
517         draw->Canvas.SetBgColor (70, 70, 70);
518         draw->Canvas.Rectangle (1, output[i].x1, output[i].y1 +
519             ((int) ((output[i].y2 - output[i].y1)*0.35)), output[i].x2 - outp
520                 (int) ((output[i].y2 - output[i].y1)*0.65));
521     }
522     else //draw switch on
523     {
524         //draw a grey rectangle
525         draw->Canvas.SetBgColor (70, 70, 70);
526         draw->Canvas.Rectangle (1, output[i].x1,
527             output[i].y1, output[i].x2 - output[i].x1,
528                 (int) ((output[i].y2 - output[i].y1)*0.65));
529     }
530 }
531 else if (output[i].id == O_BD0)
532 {
533     draw->Canvas.SetColor (102, 102, 102);
534     draw->Canvas.Circle (1, output[i].cx, output[i].cy, 10);
535     if (p_BT1)
536     {
537         draw->Canvas.SetColor (15, 15, 15);
538     }
539     else
540     {
541         draw->Canvas.SetColor (55, 55, 55);
542     }
543     draw->Canvas.Circle (1, output[i].cx, output[i].cy, 8);
544 }
545 else if (output[i].id == O_RST)
546 {
547     draw->Canvas.SetColor (102, 102, 102);
548     draw->Canvas.Circle (1, output[i].cx, output[i].cy, 10);
549
550     if (p_RST)
551     {
552         draw->Canvas.SetColor (15, 15, 15);
553     }
554     else
555     {
556         draw->Canvas.SetColor (55, 55, 55);
557     }
558     draw->Canvas.Circle (1, output[i].cx, output[i].cy, 8);
559 }
560 else if (output[i].id == O_POT1)
561 {
```



```

562     draw->Canvas.SetColor (0, 50, 215);
563     draw->Canvas.Rectangle (1, output[i].x1, output[i].y1, output[i].x2 - output[i].x1, output
564     draw->Canvas.SetColor (250, 250, 250);
565     draw->Canvas.Rectangle (1, output[i].x1 + pot1 / 2.77, output[i].y1 + 2, 10, 15);
566     }
567     else if (output[i].id == O_CPU)
568     {
569         draw->Canvas.SetFont (font);
570         int x, y, w, h;
571         draw->Canvas.SetColor (26, 26, 26);
572         draw->Canvas.Rectangle (1, output[i].x1, output[i].y1, output[i].x2 - output[i].x1, output
573
574         draw->Canvas.SetColor (230, 230, 230);
575         w = output[i].x2 - output[i].x1;
576         h = output[i].y2 - output[i].y2;
577         x = output[i].x1 + (w / 2) + 7;
578         y = output[i].y1 + (h / 2) + (Proc.length ());
579         draw->Canvas.RotatedText (Proc, x, y, 270);
580     }
581     }
582     else //if output shape is a circle
583     {
584         draw->Canvas.SetFgColor (0, 0, 0); //black
585
586         switch (output[i].id)//search for color of output
587         {
588             case O_LD0: //White using pin 19 mean value (RD0)
589                 draw->Canvas.SetBgColor (pic.pins[18].oavalue, pic.pins[18].oavalue, pic.pins[18].oavalue);
590                 break;
591             case O_LD1: //Yellow using pin 20 mean value (RD1)
592                 draw->Canvas.SetBgColor (pic.pins[19].oavalue, pic.pins[19].oavalue, 0);
593                 break;
594             case O_LPWR: //Blue using mcupwr value
595                 draw->Canvas.SetBgColor (0, 0, 200 * Window1.Get_mcupwr () + 55);
596                 break;
597             case O_RB0: //Green using pin 33 mean value (RB0)
598                 draw->Canvas.SetBgColor (0, pic.pins[32].oavalue, 0);
599                 break;
600             case O_RB1: //Red using pin 34 mean value (RB1)
601                 draw->Canvas.SetBgColor (pic.pins[33].oavalue, 0, 0);
602                 break;
603         }
604
605         //draw a LED
606         color1 = draw->Canvas.GetBgColor ();
607         int r = color1.Red () - 120;
608         int g = color1.Green () - 120;

```

```

609     int b = color1.Blue () - 120;
610     if (r < 0)r = 0;
611     if (g < 0)g = 0;
612     if (b < 0)b = 0;
613     color2.Set (r, g, b);
614     draw->Canvas.SetBgColor (color2);
615     draw->Canvas.Circle (1, output[i].x1, output[i].y1, output[i].r + 1);
616     draw->Canvas.SetBgColor (color1);
617     draw->Canvas.Circle (1, output[i].x1, output[i].y1, output[i].r - 2);
618     }
619     }
620     }
621     //end draw
622
623     if (update)
624     {
625         draw->Canvas.End ();
626         draw->Update ();
627     }
628
629     //RB0 mean value to gauge1
630     gauge1->SetValue ((pic.pins[33].oavalue - 55) / 2);
631     //RB1 mean value to gauge2
632     gauge2->SetValue ((pic.pins[32].oavalue - 55) / 2);
633
634 }
635
636 void
637 cboard_x::Run_CPU(void)
638 {
639     int i;
640     int j;
641     unsigned char pi;
642     const picpin * pins;
643     unsigned int alm[40];
644
645     int JUMPSTEPS = Window1.GetJUMPSTEPS (); //number of steps skipped
646     long int NSTEP = Window1.GetNSTEP () / MGetPinCount (); //number of steps in 100ms
647
648
649     //reset pins mean value
650     memset (alm, 0, 40 * sizeof (unsigned int));
651
652     //read pic.pins to a local variable to speed up
653     pins = pic.pins;
654
655     //Spare parts window pre process

```

```

656  if (use_spare)Window5.PreProcess ();
657
658  j = JUMPSTEPS; //step counter
659  if (Window1.Get_mcupwr ()) //if powered
660    for (i = 0; i < Window1.GetNSTEP (); i++) //repeat for number of steps in 100ms
661    {
662
663      if (j >= JUMPSTEPS)//if number of step is bigger than steps to skip
664      {
665        pic_set_pin (pic.mclr, p_RST);
666        pic_set_pin (19, p_BT1); //Set pin 19 (RD0) with button state
667        pic_set_pin (20, p_BT2); //Set pin 20 (RD1) with switch state
668      }
669
670      //verify if a breakpoint is reached if not run one instruction
671      if (!mplabxd_testbp ())pic_step ();
672      //Oscilloscope window process
673      if (use_oscope)Window4.SetSample ();
674      //Spare parts window process
675      if (use_spare)Window5.Process ();
676
677      //increment mean value counter if pin is high
678      alm[i % pic.PINCOUNT] += pins[i % pic.PINCOUNT].value;
679
680      if (j >= JUMPSTEPS)//if number of step is bigger than steps to skip
681      {
682
683        //set analog pin 2 (AN0) with value from scroll
684        pic_set_apin (2, (5.0 * pot1 / 199));
685
686        j = -1; //reset counter
687      }
688      j++; //counter increment
689    }
690
691    //calculate mean value
692    for (pi = 0; pi < pic.PINCOUNT; pi++)
693    {
694      pic.pins[pi].oavalue = (int) (((200.0 * alm[pi]) / NSTEP) + 55);
695    }
696
697    //Spare parts window pre post process
698    if (use_spare)Window5.PostProcess ();
699
700    //verifiy if LEDS need update
701    if (output_ids[O_LD0]->value != pic.pins[18].oavalue)
702    {

```

```
703     output_ids[O_LD0]->value = pic.pins[18].oavalue;
704     output_ids[O_LD0]->update = 1;
705 }
706 if (output_ids[O_LD1]->value != pic.pins[19].oavalue)
707 {
708     output_ids[O_LD1]->value = pic.pins[19].oavalue;
709     output_ids[O_LD1]->update = 1;
710 }
711 if (output_ids[O_RB0]->value != pic.pins[32].oavalue)
712 {
713     output_ids[O_RB0]->value = pic.pins[32].oavalue;
714     output_ids[O_RB0]->update = 1;
715 }
716 if (output_ids[O_RB1]->value != pic.pins[33].oavalue)
717 {
718     output_ids[O_RB1]->value = pic.pins[33].oavalue;
719     output_ids[O_RB1]->update = 1;
720 }
721 }
722 }
723
724
725 //Register the board in PICSimLab
726 board_init(BOARD_x_Name, cboard_x);
727
```

C.1.5 Integration with PICsimLab

After include the four files created for new board, the PICSimLab can be recompiled, as described in [Install from source](#).

C.1.6 Final Result

The PICSimLab board created for this tutorial are shown in the figure below.

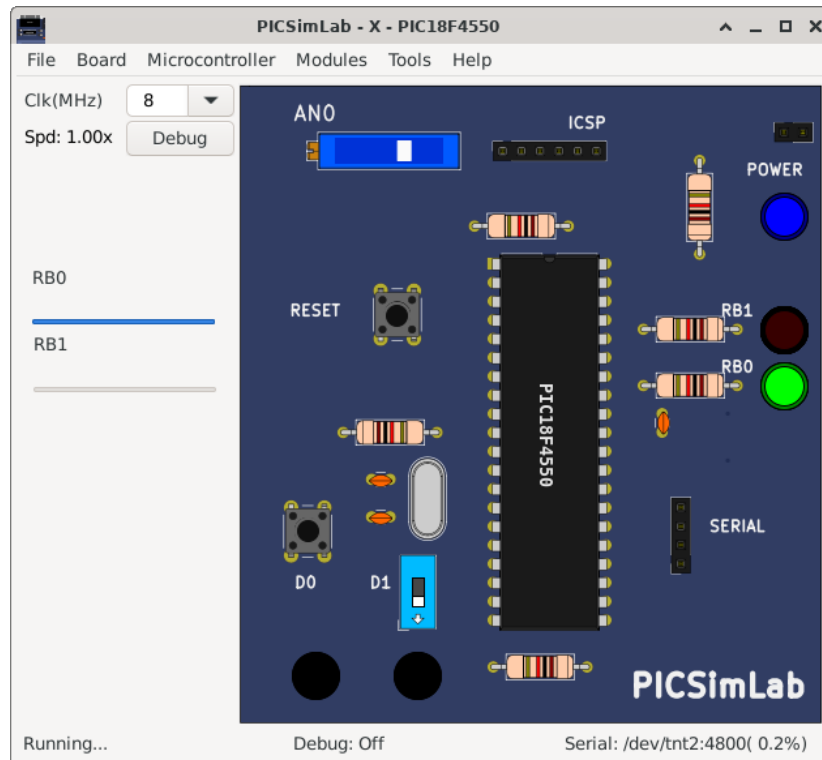

The sample program below can be used to test new board, this code is write for XC8 compiler:

```

1  #include <xc.h>;
2
3  #include "config_4550.h"
4  #include "adc.h"
5  #include "serial.h"
6  #include "itoa.h"
7
8  void main()
9  {
10     unsigned int  val;
11     char  buffer[10];
12
13     ADCON1=0x02;
14     TRISA=0xFF;
15     TRISB=0xFC;
16     TRISC=0xBF;
17     TRISD=0xFF;
18     TRISE=0x0F;
19

```

```
20  adc_init();
21  serial_init();
22
23
24  while(1)
25  {
26      val=adc_amostra(0);
27
28      if(PORTDbits.RD1)
29      {
30          if(val > 340)
31              PORTBbits.RB0=1;
32          else
33              PORTBbits.RB0=0;
34
35          if(val > 680)
36              PORTBbits.RB1=1;
37          else
38              PORTBbits.RB1=0;
39      }
40      else
41      {
42          if(PORTDbits.RD0)
43          {
44              PORTBbits.RB0=1;
45              PORTBbits.RB1=0;
46          }
47          else
48          {
49              PORTBbits.RB0=0;
50              PORTBbits.RB1=1;
51          }
52      }
53  }
54
55  serial_tx_str(itoa(val,buffer));
56  serial_tx_str("\r\n");
57  }
58
59 }
```